

# Technical Reference Guide



**YOU ASK IT.  
WE MASK IT.**®

[www.epsi.com](http://www.epsi.com)





Dear Customer,

Welcome to EPSI's newest and most up-to-date Technical Reference Guide. This literature has been created for you as an easy-to-use yet comprehensive guide when selecting the most effective industrial finishing supplies for your specific application.

Please keep in mind that this catalog is only a partial offering of over 3,000 different products stocked in our eight global locations. You will also notice that we have introduced three new product families: Booth Filters, Modular Masking and Triple Push Plugs. These new products come with the same price and availability guarantees that you have come to expect from EPSI.

For up-to-date pricing and product offerings, please contact your local EPSI representative or visit us at [www.epsi.com](http://www.epsi.com).

Sincerely,

Armen Sarajian,  
President

# EPSI Headquarters



## EPSI-Wisconsin

4221 Courtney Road  
Franksville, WI 53126 USA  
262.835.0782 Phone 262.835.0783 Fax

[www.epsi.com](http://www.epsi.com)  
[sales@epsi.com](mailto:sales@epsi.com)

## TOLL FREE ANYWHERE IN USA:

866.ASK.EPSI (866.275.3774)  
866.FAX.EPSI (866.329.3774)

# EPSI Locations



## EPSI-California

13855 Struikman Road  
Cerritos, CA 90703 USA



## EPSI-Indiana

8168 N. Zionsville Road  
Indianapolis, IN 46268 USA



## EPSI-South Carolina

407 East Smith Street  
Timmonsville, SC 29161 USA



## EPSI-Connecticut

1296 Blue Hills Avenue  
Bloomfield, CT 06002 USA



## EPSI-Europe BV

Kiotoweg 601 • 3047 BG Rotterdam  
THE NETHERLANDS  
ph: +31 (0)10 4150155 • fx: +31 (0)10 4154099  
[www.epsi-europe.com](http://www.epsi-europe.com) Email: [ask-it@epsi-europe.com](mailto:ask-it@epsi-europe.com)

## EPSI-Europe BV

Vertriebsburo Deutschland  
Pagenstecher Strasse 143  
D-49090 OSNABRUCK  
Deutschland  
ph: +49 (0)541 97761280  
fx: +49 (0)541 97761287  
[www.epsi-europe.de](http://www.epsi-europe.de)  
Email: [info@epsi.europe.de](mailto:info@epsi.europe.de)

## EPSI-China

EPSI Asia Ningbo Trading Co.,  
Ltd.  
Suite 609, Guangbo  
International Trade Center  
No. 1357, Yinxiandadao Middle  
Zhejiang, Yinzhou, NINGBO  
P.R. China  
011 86 574 8303 0602 Phone

## Custom Masking



2  
Custom Masking

## Caps



3  
Flanged Caps [FCS] 600°



4  
EZ Caps [EZY] 600°



6  
Silicone Caps [SC] 600°



10  
Flat Silicone Caps [FSC] 600°



12  
Washer Caps [WC] 600°



14  
Silicone Cone Caps [CONS] 600°



16  
EPDM Caps [EC] 475°

## Plugs



19  
Hollow Tapered Stoppers [HSTS] 600°



20  
Silicone Tapered Stoppers [STS] 600°



23  
Black EPDM Stoppers [BES] 475°



26  
Cork Stoppers [CRKR] 600°



27  
Flangeless Plugs [FLPS] 600°



27  
EPDM Flangeless Plugs [FLPE] 475°



29  
Silicone Masking Stoppers/Stems [SMS] 600°



30  
Washer Plugs [WVP] 600°



32  
Tube Insert Plugs [TIPS] 600°

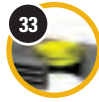

33  
Shallow Tube Plugs [TOPS] 600°



34  
Blind Hole Thread Mask Plugs [BTM] 600°



35  
Silicone Pull Plugs [SPP] 600°



38  
Silicone Weld-Nut Pull Plugs [WPP] 600°



40  
Silicone Double Washer Pull Plugs [DWP] 600°



41  
Sink-O-Mask™ Plugs [SOMS] 600°



42  
Silicone Mousetail Plugs [SMT] 600°



42  
EPDM Mousetail Plugs [EMT] 475°



43  
Thread-N-Mask Plugs [TNM] 185°



44  
EPDM Pull Plugs [EPP] 475°



46  
Silicone Triple Push Plug [TPP] 600°

## Tapes and Discs



47  
Rusty Polyester Tape [R12] 430°



48  
Green Polyester Tape [A12] 400°



50  
Ultra Orange Tape [O12] 430°



52  
Green Wishbone Discs [AW12] 400°



54  
Green Polyester Discs [AD12] 400°



56  
Green Polyester Donuts [AH12] 400°



57  
Automated Tape Dispenser [M1000]



57  
Caliper



58  
1 mil Polyimide Tape [K12] 500°



58  
2 mil Polyimide Tape [K22] 600°



60  
2 mil Polyimide Discs [KD22] 600°



60  
2 mil Polyimide Wishbone Discs [KW22] 600°



62  
Blue Polyester Tape [B12] 350°



63  
Red Polyester Tape [D12] 350°



64  
Med/Hi-Temp Crepe Tape [C11] 300°



65  
Hi-Temp Crepe Tape [C21] 325°



66  
Hi-Temp Crepe Discs [CD21] 325°



68  
Hi-Temp Crepe w/ Film [PPFC21] 325°



69  
Silicone Self-Fusing Tape [S10/S20/S30] 600°



70  
Fiberglass Tape [F12] 500°



71  
Fiberglass Discs [FD12] 500°



72  
Aluminum Tape [M10] 325°



73  
Lead Foil Tape [P12] 225°



74  
Electroplating Vinyl Tape [V12] 176°



75  
Vinyl Discs [VD12] 176°



76  
General Purpose Tape [V10] 176°



77  
Non-Adhesive Vinyl Tape [V71] 176°



866-ASK-EPSI (866-275-3774)  
866-FAX-EPSI (866-329-3774)

Order online at  
[www.epsi.com](http://www.epsi.com)

**YOU ASK IT.  
WE MASK IT.®**



## 3M Tapes & Discs



Crepe Tape - C10  
[3M 2364] 300°



Crepe Tape - C12  
[3M 2380] 325°



Vinyl Tape - V14  
[3M 470] 170°



Lead Foil Tape - P14  
[3M 421] 225°

## Hooks



V Hooks  
[HV]



V Hooks with 90°  
Bend [HV90]



S Hooks  
[HS]



C Hooks  
[HC]



CV Hooks  
[HCV]



V-Style Locking  
Hooks [HKVL]



Claw Hooks  
[CLAW]



Sheet & Pipe  
Suspender [HKSC]



Spring Tube Hooks  
[HKRO]



Swivel Hooks  
[SWIVEL H]



Swivel Hooks  
[SWIVEL R & V]

## Tubing and Cord



Spring Tube  
Hooks



Silicone Foam  
Cord [CRDF] 600°



Solid Silicone  
Cord [CRDS] 600°



Flexible Star Tubing-  
Silicone [FSTS] 600°

## Sheeting



Silicone Foam  
Sheeting [SHFS] 600°



Silicone Rubber  
Sheeting [SHRS] 600°



Silicone Magnetic  
Sheeting [SHMS] 500°



Vinyl Magnetic  
Sheeting [SHMV] 176°

## Miscellaneous



Oven Cleaning  
Film [TC-250] 450°



Starter Kits  
[KITS]  
Caps/Plugs



Starter Kits  
[KITS]  
Plugs



Starter Kits  
[KITS]  
Plugs



Powder Coating  
Filters [FILC]



Paint Pockets  
Liquid Filters  
[PGP/PGB/PWP/PWB]



Cork Spacer Pads  
[CRSP]



Elastomer  
Chart



Conversion  
Table



Terms &  
Conditions



866-ASK-EPSI (866-275-3774)  
866-FAX-EPSI (866-329-3774)

Order online at  
[www.epsi.com](http://www.epsi.com)

**YOU ASK IT.  
WE MASK IT.®**

# Custom Masks

## Go Custom

*THE TIME IS NOW!*

Are you tired of taping? Are long term job opportunities passing you by because you can't turn them around fast enough?

Are you constantly grinding burrs and going through cartons of touch up paint? Don't settle for getting by. Go Custom!

A custom mask is designed specifically for your part, to speed up application, removal and protect areas from unwanted coating coverages. You won't spend entire days masking batches, you'll spend more time coating them. Start providing your customers with the finishes they deserve!



866-ASK-EPSI (866-275-3774)  
866-FAX-EPSI (866-329-3774)

2

Order online at  
[www.epsi.com](http://www.epsi.com)

**YOU ASK IT.  
WE MASK IT.®**

# FCS Flanged Caps

600°F (315°C)



- Flanged Washer Area is Ideal for Masking Around Lead-In Chamfer of Threaded Holes
- Can be Used in Conjunction with a Dowel or Other Insertion Tool for Easier Application
- Hollow Design Ensures Easy Insertion
- Flanged Caps are Reusable, and Will Not Melt or Harden

## TYPICAL INDUSTRIES USED

Powder Coating, E-Coating, Plating and Anodizing

## TYPICAL APPLICATIONS

Used as a plug in threaded holes, and chamfered holes. Can also be used as a substitute for an equivalent silicone cap.

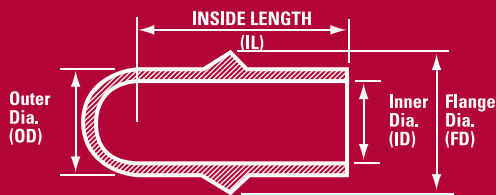
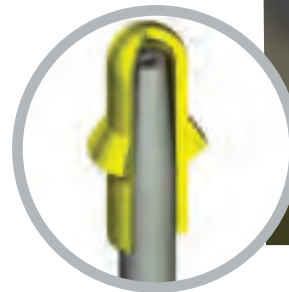

## FCS SERIES

PART NUMBER	COLOR	ID (in)	STANDARD			METRIC			BOX QTY	
			OD (in)	FD (in)	IL (in)	OD (mm)	FD (mm)	IL (mm)		
FCS 012031-L	YELLOW	0.173	0.291	0.472	1.220	4.4	7.4	12.0	31.0	250
FCS 015032-N	PINK	0.224	0.343	0.579	1.260	5.7	8.7	14.7	32.0	250
FCS 016033-C	CLEAR	0.303	0.421	0.622	1.299	7.7	10.7	15.8	33.0	250
FCS 018034-Y	GREY	0.421	0.539	0.709	1.339	10.7	13.7	18.0	34.0	250

■ Current pricing and additional sizes available at [www.epsi.com](http://www.epsi.com)



866-ASK-EPSI (866-275-3774)  
866-FAX-EPSI (866-329-3774)

3

Order online at [www.epsi.com](http://www.epsi.com)

**YOU ASK IT.  
WE MASK IT.®**

# EZY<sup>Easy</sup> Caps

600°F (315°C)



- EZY<sup>TM</sup> Caps are Ideal for Large Diameter or Long Length Products
- Specially Designed Internal Ring Allows for Easy Placement, and a Liquid-Tight Seal
- Oversized Head for Easy Removal
- Many Sizes Available with Built-in Air-Vent to Eliminate the Effects of Pressure Build-Up
- EZY<sup>TM</sup> Caps are Reusable, and Will Not Melt or Harden
- EZY<sup>TM</sup> Caps Offer Fine Line Masking

## TYPICAL INDUSTRIES USED

Powder Coating, E-Coating, Plating and Anodizing

## TYPICAL APPLICATIONS

Used as a cap over threaded studs, dowels, and protrusions.

## PRODUCT DESCRIPTION

Our Easy Cap (EZY<sup>TM</sup>) product line is the best choice when masking



off threaded studs or protrusions. Many EZY<sup>TM</sup> caps are molded with an air vent, which acts as a relief valve for applications where internal pressure is a problem. All EZY<sup>TM</sup> caps feature an oversized head and a unique internal gripping design, which makes application and removal easy.

- Current pricing and additional sizes available at [www.epsi.com](http://www.epsi.com)

## HELPFUL HINTS

- If internal pressure is causing blowout, place a slit in or remove the nipple. This will allow for venting of internal pressure. (Not recommended for immersion coatings.)
- Due to the internal ring, a much smaller ID can be used compared with a standard cap.
- Size at least 10% less than the stud OD.



866-ASK-EPSI (866-275-3774)  
866-FAX-EPSI (866-329-3774)

4

Order online at  
[www.epsi.com](http://www.epsi.com)

**YOU ASK IT.  
WE MASK IT.**



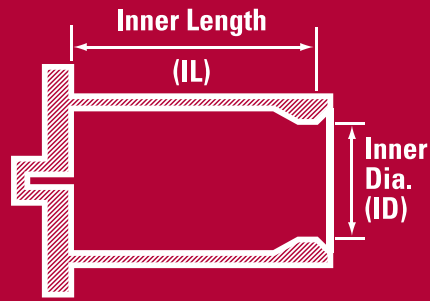

## EZY SERIES

PART NUMBER	COLOR	STANDARD		METRIC		BOX QTY
		ID (in)	IL (in)	ID (mm)	IL (mm)	
EZY 0187X1377-F	RUSTY	0.187	1.377	4.7	35.0	500
EZY 0236X1180-F	RUSTY	0.236	1.180	6.0	30.0	250
EZY 0255X0910-F	RUSTY	0.255	0.910	6.5	23.1	250
EZY 0270X1200-F	RUSTY	0.270	1.200	6.8	30.5	250
EZY 0275X1180-F	RUSTY	0.275	1.180	7.0	30.0	250
EZY 0294X1330-F	RUSTY	0.294	1.330	7.5	33.8	250
EZY 0315X0974-F	RUSTY	0.315	0.974	8.0	24.7	250
EZY 0375X1421-F	RUSTY	0.375	1.421	9.5	36.0	250
EZY 0433X0950-F	RUSTY	0.433	0.950	11.0	24.1	250
EZY 0433X1180-F	RUSTY	0.433	1.180	11.0	30.0	250
EZY 0456X2000-F	RUSTY	0.456	2.000	11.6	50.8	250
EZY 0531X1180-F	RUSTY	0.531	1.180	13.5	30.0	100
EZY 0687X1180-F	RUSTY	0.687	1.180	17.5	30.0	100
EZY 0800X3230-F	RUSTY	0.800	3.230	20.3	82.0	50
EZY 0906X3500-F	RUSTY	0.906	3.500	23.0	88.9	50
EZY 0963X3000-F	RUSTY	0.963	3.000	24.5	76.2	50
EZY 1125X5000-F	RUSTY	1.125	5.000	28.6	127.0	50
EZY 1288X2500-F	RUSTY	1.288	2.500	32.7	63.5	50
EZY 2250X1920-F	RUSTY	2.250	1.920	57.2	48.8	25
EZY 2500X2420-F	RUSTY	2.500	2.420	63.5	61.5	25
EZY 2750X2670-F	RUSTY	2.750	2.670	69.9	67.8	25
EZY 3000X2920-C	CLEAR	3.000	2.920	76.2	74.2	25

## Here's why you should use EPSI's EZY...

Cut here if venting is needed



Friction fit causes suction, making cap difficult to remove (cap may have to be cut off).



Oversized head and limited friction (grip-ring) make for quick masking & demasking.



866-ASK-EPSI (866-275-3774)  
866-FAX-EPSI (866-329-3774)

5

Order online at  
[www.epsi.com](http://www.epsi.com)

**YOU ASK IT.  
WE MASK IT.**

# SC Silicone Caps

600°F (315°C)



- Can Be Used as Both Cap and Plug.
- Flexible Enough to Conform to Irregular Geometry
- Round Top Profile Allows for Easy Insertion Into Holes.
- Silicone Caps are Reusable, and Will Not Melt or Harden.
- Color Coded for Increased Visibility and Sorting During Reuse.

## TYPICAL INDUSTRY USES

Powder Coating, E-Coating, Plating and Anodizing

## TYPICAL APPLICATIONS

Used as a cap over threaded studs, dowels, and protrusions. Used as a plug for tapped holes, irregular contours and threaded holes.



## PRODUCT DESCRIPTION

Our Silicone Cap (SC) product line is the industry standard for general masking applications. Their versatile nature allows them to fit over extensions, threaded studs, PEMS and dowels, as well as be used as a plug for tapped holes, irregular contours and threaded holes. Our high temperature silicone is specially formulated to ensure reusability.

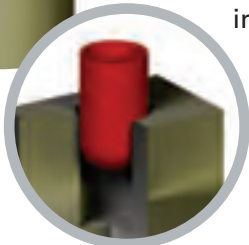

## HELPFUL HINTS

- When sizing parts as a cap, the ID of the cap should be 2 - 5% smaller than the stud diameter.
- To ensure easy removal, select a cap length that is slightly longer than the masking length of the stud. This is especially important if the cap ID is less than 5% of the stud diameter.
- When sizing parts as a plug, the OD should be at least 7% larger than the hole diameter.
- If used to cover tube ends in powder coating, a small slit in the top of the cap will prevent blow-off. (See EZY™ Caps.)

**CAUTION: Due to the low tear resistance of silicone; do not use pliers or other sharp tools for removal. (See EC Caps for higher tear resistance caps.)**



866-ASK-EPSI (866-275-3774)  
866-FAX-EPSI (866-329-3774)

6

Order online at  
[www.epsi.com](http://www.epsi.com)

**YOU ASK IT.  
WE MASK IT.®**

# SC SERIES

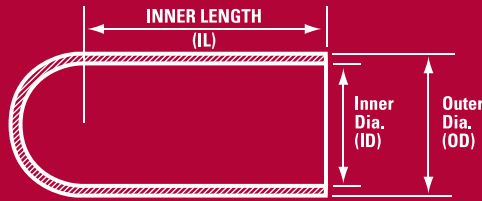

PART NUMBER	COLOR	STANDARD			METRIC			BOX QTY
		ID (in)	OD (in)	IL (in)	ID (mm)	OD (mm)	IL (mm)	
SC 0020X0500-R	RED	0.020	0.080	0.500	0.5	2.0	12.7	1000
SC 0035X0500-W	WHITE	0.035	0.095	0.500	0.9	2.4	12.7	1000
SC 0040X0750-U	BLUE	0.040	0.130	0.750	1.0	3.3	19.1	1000
SC 0062X0750-L	YELLOW	0.062	0.152	0.750	1.6	3.9	19.1	1000
SC 0070X1000-G	GREEN	0.070	0.160	1.000	1.8	4.1	25.4	1000
SC 0080X0750-O	ORANGE	0.080	0.200	0.750	2.0	5.1	19.1	1000
SC 0093X0500-N	PINK	0.093	0.213	0.500	2.4	5.4	12.7	1000
SC 0093X0750-N	PINK	0.093	0.193	0.750	2.4	4.9	19.1	1000
SC 0100X0500-G	GREEN	0.100	0.200	0.500	2.5	5.1	12.7	1000
SC 0100X1000-G	GREEN	0.100	0.200	1.000	2.5	5.1	25.4	1000
SC 0109X0500-L	YELLOW	0.109	0.229	0.500	2.8	5.8	12.7	1000
SC 0109X0750-Y	GREY	0.109	0.209	0.750	2.8	5.3	19.1	1000
SC 0125X0500-U	BLUE	0.125	0.225	0.500	3.2	5.7	12.7	1000
SC 0125X1000-B	BLACK	0.125	0.225	1.000	3.2	5.7	25.4	1000
SC 0125X1500-C	CLEAR	0.125	0.245	1.500	3.2	6.2	38.1	1000
SC 0135X0625-C	CLEAR	0.135	0.255	0.625	3.4	6.5	15.9	1000
SC 0140X0250-W	WHITE	0.140	0.260	0.250	3.6	6.6	6.5	1000
SC 0140X0500-C	CLEAR	0.140	0.260	0.500	3.6	6.6	12.7	1000
SC 0140X1000-W	WHITE	0.140	0.260	1.000	3.6	6.6	25.4	1000
SC 0140X1500-C	CLEAR	0.140	0.260	1.500	3.6	6.6	38.1	1000
SC 0148X0500-N	PINK	0.148	0.268	0.500	3.8	6.8	12.7	1000
SC 0148X0750-N	PINK	0.148	0.268	0.750	3.8	6.8	19.1	1000
SC 0148X1000-N	PINK	0.148	0.268	1.000	3.8	6.8	25.4	1000
SC 0156X0500-G	GREEN	0.156	0.276	0.500	4.0	7.0	12.7	1000
SC 0156X1000-L	YELLOW	0.156	0.276	1.000	4.0	7.0	25.4	1000
SC 0172X0500-Y	GREY	0.172	0.292	0.500	4.4	7.4	12.7	1000
SC 0172X1000-U	BLUE	0.172	0.292	1.000	4.4	7.4	25.4	1000
SC 0172X1500-U	BLUE	0.172	0.292	1.500	4.4	7.4	38.1	1000
SC 0180X1000-B	BLACK	0.180	0.300	1.000	4.6	7.6	25.4	1000
SC 0187X0500-W	WHITE	0.187	0.307	0.500	4.7	7.8	12.7	1000
SC 0187X1000-C	CLEAR	0.187	0.307	1.000	4.7	7.8	25.4	1000
SC 0187X1500-C	CLEAR	0.187	0.307	1.500	4.7	7.8	38.1	1000
SC 0197X0500-Z	BROWN	0.197	0.317	0.500	5.0	8.1	12.7	1000
SC 0218X1000-Y	GREY	0.218	0.338	1.000	5.5	8.6	25.4	1000
SC 0223X0500-N	PINK	0.223	0.343	0.500	5.7	8.7	12.7	1000
SC 0223X0750-U	BLUE	0.223	0.343	0.750	5.7	8.7	19.1	1000
SC 0223X1000-N	PINK	0.223	0.343	1.000	5.7	8.7	25.4	1000
SC 0223X1500-N	PINK	0.223	0.343	1.500	5.7	8.7	38.1	1000
SC 0234X0500-G	GREEN	0.234	0.354	0.500	5.9	9.0	12.7	1000



866-ASK-EPSI (866-275-3774)  
866-FAX-EPSI (866-329-3774)

Order online at  
[www.epsi.com](http://www.epsi.com)



# SC SERIES

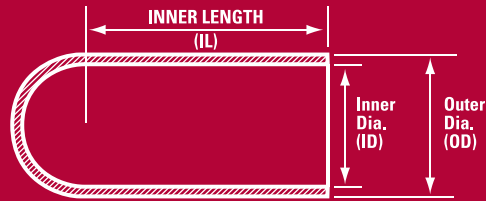

PART NUMBER	COLOR	STANDARD			METRIC			BOX QTY
		ID (in)	OD (in)	IL (in)	ID (mm)	OD (mm)	IL (mm)	
SC 0234X0787-G	GREEN	0.234	0.354	0.787	5.9	9.0	20.0	1000
SC 0234X1000-G	GREEN	0.234	0.354	1.000	5.9	9.0	25.4	1000
SC 0234X1500-L	YELLOW	0.234	0.354	1.500	5.9	9.0	38.1	1000
SC 0250X1000-Y	GREY	0.250	0.370	1.000	6.4	9.4	25.4	1000
SC 0250X1500-C	CLEAR	0.250	0.370	1.500	6.4	9.4	38.1	1000
SC 0260X1000-O	ORANGE	0.260	0.380	1.000	6.6	9.7	25.4	500
SC 0281X1000-U	BLUE	0.281	0.401	1.000	7.1	10.2	25.4	500
SC 0295X0500-B	BLACK	0.295	0.415	0.500	7.5	10.5	12.7	500
SC 0295X0750-B	BLACK	0.295	0.415	0.750	7.5	10.5	19.1	500
SC 0295X1000-B	BLACK	0.295	0.415	1.000	7.5	10.5	25.4	500
SC 0295X1500-B	BLACK	0.295	0.415	1.500	7.5	10.5	38.1	500
SC 0312X1000-W	WHITE	0.312	0.432	1.000	7.9	11.0	25.4	500
SC 0312X1500-N	PINK	0.312	0.432	1.500	7.9	11.0	38.1	500
SC 0312X2000-W	WHITE	0.312	0.432	2.000	7.9	11.0	50.8	500
SC 0340X1000-P	PURPLE	0.340	0.460	1.000	8.6	11.7	25.4	500
SC 0340X2000-C	CLEAR	0.340	0.460	2.000	8.6	11.7	50.8	500
SC 0355X1000-C	CLEAR	0.355	0.475	1.000	9.0	12.1	25.4	500
SC 0355X1500-G	GREEN	0.355	0.475	1.500	9.0	12.1	38.1	500
SC 0366X1500-R	RED	0.366	0.486	1.500	9.3	12.3	38.1	500
SC 0375X0750-L	YELLOW	0.375	0.495	0.750	9.5	12.6	19.1	500
SC 0375X1000-L	YELLOW	0.375	0.495	1.000	9.5	12.6	25.4	500
SC 0375X1500-Y	GREY	0.375	0.495	1.500	9.5	12.6	38.1	500
SC 0406X1000-U	BLUE	0.406	0.526	1.000	10.3	13.4	25.4	250
SC 0437X1000-B	BLACK	0.437	0.557	1.000	11.1	14.1	25.4	250
SC 0456X0500-C	CLEAR	0.456	0.556	0.500	11.6	14.1	12.7	250
SC 0456X1500-C	CLEAR	0.456	0.556	1.500	11.6	14.1	38.1	250
SC 0468X1000-W	WHITE	0.468	0.588	1.000	11.9	14.9	25.4	250
SC 0480X1500-N	PINK	0.480	0.600	1.500	12.2	15.2	38.1	250
SC 0500X1500-G	GREEN	0.500	0.620	1.500	12.7	15.7	38.1	250
SC 0535X1500-U	BLUE	0.535	0.635	1.500	13.6	16.1	38.1	250
SC 0535X3000-C	CLEAR	0.535	0.655	3.000	13.6	16.6	76.2	250
SC 0562X1500-C	CLEAR	0.562	0.682	1.500	14.3	17.3	38.1	250
SC 0590X4720-C	CLEAR	0.590	0.710	4.720	15.0	18.0	120.0	100
SC 0600X1500-C	CLEAR	0.600	0.708	1.500	15.2	18.0	38.1	250
SC 0625X1125-C	CLEAR	0.625	0.745	1.125	15.9	18.9	28.6	250
SC 0625X1500-C	CLEAR	0.625	0.745	1.500	15.9	18.9	38.1	250
SC 0625X2500-C	CLEAR	0.625	0.745	2.500	15.9	18.9	63.5	250
SC 0687X1000-C	CLEAR	0.687	0.807	1.000	17.4	20.5	25.4	100
SC 0687X1500-C	CLEAR	0.687	0.807	1.500	17.4	20.5	38.1	100



866-ASK-EPSI (866-275-3774)  
866-FAX-EPSI (866-329-3774)

Order online at  
[www.epsi.com](http://www.epsi.com)





## SC SERIES

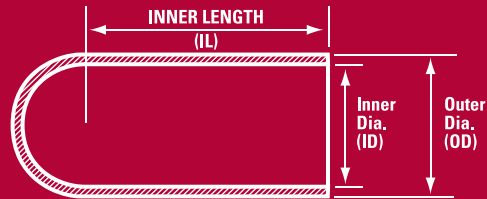

PART NUMBER	COLOR	STANDARD			METRIC			BOX QTY
		ID (in)	OD (in)	IL (in)	ID (mm)	OD (mm)	IL (mm)	
SC 0730X1500-C	CLEAR	0.730	0.850	1.500	18.5	21.6	38.1	100
SC 0750X1500-C	CLEAR	0.750	0.870	1.500	19.1	22.1	38.1	100
SC 0750X3500-C	CLEAR	0.750	0.870	3.500	19.1	22.1	88.9	100
SC 0780X1500-C	CLEAR	0.780	0.900	1.500	19.8	22.9	38.1	100
SC 0812X1500-C	CLEAR	0.812	0.932	1.500	20.6	23.7	38.1	100
SC 0875X1500-C	CLEAR	0.875	0.995	1.500	22.2	25.3	38.1	100
SC 0937X1500-C	CLEAR	0.937	1.057	1.500	23.8	26.8	38.1	100
SC 0970X1500-C	CLEAR	0.970	1.090	1.500	24.6	27.7	38.1	100
SC 0970X4000-C	CLEAR	0.970	1.090	4.000	24.6	27.7	101.6	100
SC 1000X1500-C	CLEAR	1.000	1.120	1.500	25.4	28.4	38.1	100
SC 1000X2000-C	CLEAR	1.000	1.120	2.000	25.4	28.4	50.8	100
SC 1062X2000-C	CLEAR	1.062	1.182	2.000	27.0	30.0	50.8	100
SC 1125X1500-C	CLEAR	1.125	1.245	1.500	28.6	31.6	38.1	100
SC 1187X1500-C	CLEAR	1.187	1.307	1.500	30.1	33.2	38.1	100
SC 1250X1500-C	CLEAR	1.250	1.370	1.500	31.8	34.8	38.1	100
SC 1350X1500-C	CLEAR	1.350	1.470	1.500	34.3	37.3	38.1	100
SC 1350X1750-C	CLEAR	1.350	1.470	1.750	34.3	37.3	44.5	100
SC 1380X1000-C	CLEAR	1.380	1.500	1.000	35.1	38.1	25.4	50
SC 1500X1000-C	CLEAR	1.500	1.620	1.000	38.1	41.1	25.4	50
SC 1500X1500-C	CLEAR	1.500	1.620	1.500	38.1	41.1	38.1	50
SC 1500X1750-C	CLEAR	1.500	1.620	1.750	38.1	41.1	44.5	50
SC 1625X2000-C	CLEAR	1.625	1.745	2.000	41.3	44.3	50.8	50
SC 1750X1500-C	CLEAR	1.750	1.870	1.500	44.5	47.5	38.1	50
SC 1750X2000-C	CLEAR	1.750	1.870	2.000	44.5	47.5	50.8	50
SC 1875X2000-C	CLEAR	1.875	1.995	2.000	47.6	50.7	50.8	50
SC 2000X2000-C	CLEAR	2.000	2.120	2.000	50.8	53.8	50.8	25

Starter Kit Available. See page 107



**Starter kits are ideal for engineers, production managers and masking personnel.**

■ Current pricing and additional sizes available at [www.epsi.com](http://www.epsi.com)



866-ASK-EPSI (866-275-3774)  
866-FAX-EPSI (866-329-3774)

Order online at  
[www.epsi.com](http://www.epsi.com)

**YOU ASK IT.  
WE MASK IT.®**

# FSC Flat Silicone Caps

600°F (315°C)



- Reduces Creepage in Applications Where Temperatures Change Rapidly
- Flexible Enough to Conform to Irregular Geometry

- Flat Top Aids Insertion and Minimizes any Air Trap
- Flat Silicone Caps are Reusable, and Will Not Melt or Harden

## TYPICAL INDUSTRIES USED

Powder Coating, E-Coating, Plating and Anodizing

## TYPICAL APPLICATIONS

Used as a cap over threaded studs, dowels, and protrusions.



## PRODUCT DESCRIPTION

Our Flat Silicone Cap (FSC) product line is an alternative to our Silicone Cap (SC) product line for capping applications. Their versatile nature allows them to fit over extrusions, threaded studs, PEMS and dowels. Our high temperature Silicone is specially formulated to ensure reusability and economy during masking.

## HELPFUL HINTS

- Alternate to many Silicone Cap (SC) sizes.
- When sizing parts as a cap, the ID of the cap should be 2 - 5% smaller than the stud diameter.



866-ASK-EPSI (866-275-3774)  
866-FAX-EPSI (866-329-3774)

10

Order online at  
[www.epsi.com](http://www.epsi.com)

**YOU ASK IT.  
WE MASK IT.®**

# FSC SERIES

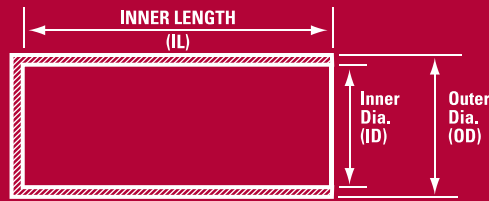

PART NUMBER	COLOR	STANDARD			METRIC			BOX QTY
		ID (in)	OD (in)	IL (in)	ID (mm)	OD (mm)	IL (mm)	
FSC 0070X1000-F	RUSTY	0.070	0.190	1.000	1.8	4.8	25.4	1000
FSC 0100X1000-F	RUSTY	0.100	0.220	1.000	2.5	5.6	25.4	1000
FSC 0100X1120-C	CLEAR	0.100	0.220	1.120	2.5	5.6	28.4	1000
FSC 0120X0400-C	CLEAR	0.120	0.240	0.400	3.0	6.0	10.1	1000
FSC 0148X1000-F	RUSTY	0.148	0.268	1.000	3.8	6.8	25.4	1000
FSC 0175X1000-F	RUSTY	0.175	0.295	1.000	4.4	7.5	25.4	1000
FSC 0223X1500-F	RUSTY	0.223	0.343	1.500	5.7	8.7	38.1	1000
FSC 0355X1500-F	RUSTY	0.355	0.475	1.500	9.0	12.1	38.1	500
FSC 0375X1500-F	RUSTY	0.375	0.495	1.500	9.5	12.6	38.1	500
FSC 0456X1500-F	RUSTY	0.456	0.576	1.500	11.6	14.6	38.1	500
FSC 0515X0728-C	CLEAR	0.515	0.635	0.728	13.1	16.1	18.5	250
FSC 0535X1500-F	RUSTY	0.535	0.655	1.500	13.6	16.6	38.1	250
FSC 0600X1500-F	RUSTY	0.600	0.720	1.500	15.2	18.3	38.1	250
FSC 0640X2000-B	BLACK	0.640	0.760	2.000	16.3	19.3	50.8	250
FSC 0730X1500-F	RUSTY	0.730	0.850	1.500	18.5	21.6	38.1	250
FSC 0736X0728-C	CLEAR	0.736	0.856	0.728	18.7	21.7	18.5	250
FSC 0855X1500-F	RUSTY	0.855	0.975	1.500	21.7	24.8	38.1	250
FSC 0980X1500-F	RUSTY	0.980	1.100	1.500	24.9	27.9	38.1	250
FSC 1106X0905-C	CLEAR	1.106	1.226	0.905	28.1	31.1	23.0	250
FSC 1291X0905-C	CLEAR	1.291	1.449	0.905	32.8	36.8	23.0	100
FSC 1555X1102-C	CLEAR	1.555	1.675	1.102	39.5	42.5	28.0	100
FSC 1772X0670-R	RED	1.772	2.126	0.670	45.0	54.0	17.0	100
FSC 1850X1102-C	CLEAR	1.850	1.970	1.102	47.0	50.0	28.0	100



866-ASK-EPSI (866-275-3774)  
866-FAX-EPSI (866-329-3774)

Order online at  
[www.epsi.com](http://www.epsi.com)



# WC Washer Caps

600°F (315°C)



- Can Be Used as Both a Cap and Plug
- Washer Feature Creates a Grounding Area Around Holes and Studs
- Flexible Enough to Conform to Irregular Geometry
- Washer Feature Creates Area Free from Powder for Assembly Purposes

## TYPICAL INDUSTRIES USED

Powder Coating, E-Coating, Plating and Anodizing

## TYPICAL APPLICATIONS

Used as a cap over threaded studs, dowels, and protrusions. Used as a plug for tapped holes, irregular contours and threaded holes. The washer feature creates a grounding area around holes and studs.

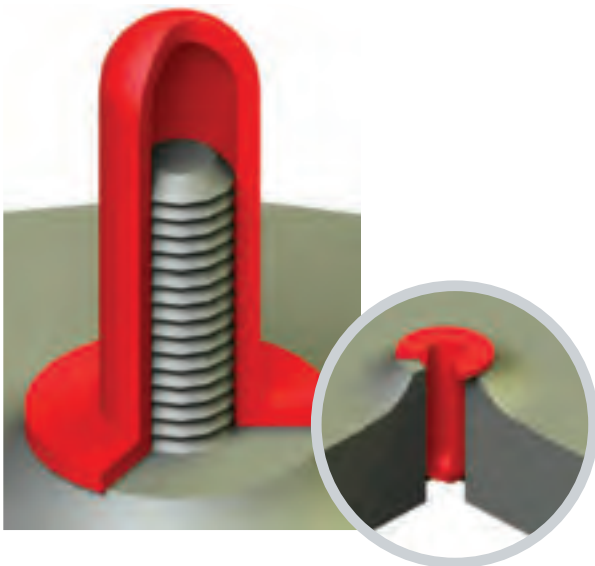

## PRODUCT DESCRIPTION

Our Washer Cap (WC) product line is the clear choice when masking off holes or studs and a surrounding surface for grounding. Their versatile nature allow them to fit over extrusions, threaded studs, PEMS and dowels, as well as be used as a plug for tapped holes, irregular contours and threaded holes. Our high temperature silicone is specially formulated to ensure stability at elevated temperatures.

## HELPFUL HINTS

- For other washer diameters, EPSI can die-cut a silicone foam donut shaped washer, or donut tape die-cut to be used under the cap.
- SC-series caps can be nested inside the washer cap to create smaller ID's.



866-ASK-EPSI (866-275-3774)  
866-FAX-EPSI (866-329-3774)

12

Order online at  
[www.epsi.com](http://www.epsi.com)

**YOU ASK IT.  
WE MASK IT.®**



# WC SERIES

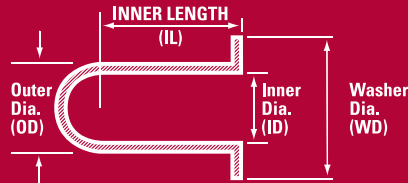

PART NUMBER	COLOR	ID (in)	STANDARD			METRIC				BOX QTY
			OD (in)	WD (in)	IL (in)	ID (mm)	OD (mm)	WD (mm)	IL (mm)	
WC 0106X0472-G	GREEN	0.106	0.246	0.472	1.000	2.7	6.2	12.0	25.4	500
WC 0125X0500-C	CLEAR	0.125	0.265	0.500	1.000	3.2	6.7	12.7	25.4	500
WC 0140X0500-C	CLEAR	0.140	0.320	0.500	1.000	3.6	8.1	12.7	25.4	500
WC 0146X0472-N	PINK	0.146	0.266	0.472	1.000	3.7	6.8	12.0	25.4	500
WC 0156X0500-C	CLEAR	0.156	0.316	0.500	1.000	4.0	8.0	12.7	25.4	500
WC 0172X0500-C	CLEAR	0.172	0.372	0.500	1.000	4.4	9.4	12.7	25.4	500
WC 0180X0600-G	GREEN	0.180	0.320	0.600	1.000	4.6	8.1	15.2	25.4	500
WC 0220X0590-R	RED	0.220	0.360	0.590	1.000	5.6	9.1	15.0	25.4	500
WC 0220X0787-C	CLEAR	0.220	0.340	0.787	1.000	5.6	8.6	20.0	25.4	500
WC 0240X0500-F	RUSTY	0.240	0.360	0.500	1.000	6.1	9.1	12.7	25.4	250
WC 0295X0700-B	BLACK	0.295	0.435	0.700	1.000	7.5	11.0	17.8	25.4	250
WC 0300X0675-C	CLEAR	0.300	0.420	0.675	1.000	7.6	10.7	17.1	25.4	250
WC 0354X0787-N	PINK	0.354	0.474	0.787	1.500	9.0	12.0	20.0	38.1	250
WC 0375X0825-L	YELLOW	0.375	0.495	0.825	1.000	9.5	12.6	21.0	25.4	250
WC 0453X0984-C	CLEAR	0.453	0.653	0.984	1.500	11.5	16.6	25.0	38.1	250
WC 0460X0700-C	CLEAR	0.460	0.580	0.700	1.000	11.7	14.7	17.8	25.4	250
WC 0500X1000-C	CLEAR	0.500	0.620	1.000	1.000	12.7	15.7	25.4	25.4	250
WC 0615X1180-F	RUSTY	0.615	0.800	1.180	1.500	15.6	20.3	30.0	38.1	250
WC 0780X1475-Y	GREY	0.780	0.980	1.475	1.500	19.8	24.9	37.5	38.1	250



866-ASK-EPSI (866-275-3774)  
866-FAX-EPSI (866-329-3774)

Order online at  
[www.epsi.com](http://www.epsi.com)



# CON Caps

600°F (315°C)



- Conical Profile Allows for Easy Insertion as a Plug
- Washer Feature Creates a Grounding Area Around Holes and Studs
- Will Fit Multiple Diameter Threads When Used as a Cap
- Flexible Enough to Conform to Irregular Geometry, Great For Square Holes
- Silicone Cone Caps are Reusable, and Will Not Melt or Harden

## TYPICAL INDUSTRIES USED

Powder Coating, E-Coating, Plating and Anodizing

## TYPICAL APPLICATIONS

Used as a cap over threaded studs, dowels, and protrusions. Used as a plug for tapped holes, irregular contours and threaded holes.



## HELPFUL HINTS

- Versatile enough to be used as caps, stoppers, plug in any variety of applications.
- When sizing parts as a cap, the ID of the cap should be 2 - 5% smaller than the stud diameter.

- To ensure easy removal, select a cap length that is at least 1/4" longer than the masking length of the stud. This is especially important if the cap ID is less than 5% of the stud diameter.

## PRODUCT DESCRIPTION

Our Cone Cap (CON) product line is an alternative to our Washer Cap (WC) product line when masking off holes or studs and a surrounding surface for grounding. Their versatile nature allow them to fit over extrusions, threaded studs, PEMS and dowels, as well as be used as a plug for tapped holes, irregular contours and threaded holes. Our high temperature silicone is specially formulated to ensure stability at elevated temperatures, to ensure reliable masking with every part.



866-ASK-EPSI (866-275-3774)  
866-FAX-EPSI (866-329-3774)

14

Order online at  
[www.epsi.com](http://www.epsi.com)

**YOU ASK IT.  
WE MASK IT.®**

# Silicone CONS CAPS

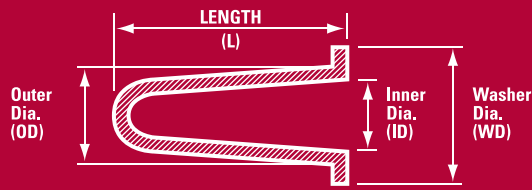

PART NUMBER	COLOR	ID (in)	STANDARD			METRIC				BOX QTY
			OD (in)	WD (in)	L (in)	ID (mm)	OD (mm)	WD (mm)	L (mm)	
CONS 00613-C	CLEAR	0.130	0.250	0.500	0.906	3.3	6.4	12.7	23.0	500
CONS 00813-F	RUSTY	0.216	0.316	0.500	1.000	5.5	8.0	12.7	25.4	500
CONS 00916-L	YELLOW	0.177	0.335	0.625	1.000	4.5	8.5	15.9	25.4	500
CONS 01017-Z	BROWN	0.197	0.394	0.650	1.102	5.0	10.0	16.5	28.0	500
CONS 01116-C	CLEAR	0.230	0.400	0.635	1.100	5.8	10.2	16.1	27.9	250
CONS 01419-B	BLACK	0.315	0.551	0.750	1.417	8.0	14.0	19.1	36.0	250
CONS 01725-G	GREEN	0.453	0.689	0.980	1.500	11.5	17.5	24.9	38.1	250
CONS 02028-U	BLUE	0.532	0.767	1.100	2.009	13.5	19.5	27.9	51.0	100
CONS 02125-R	RED	0.583	0.819	1.000	1.929	14.8	20.8	25.4	49.0	100
CONS 02231-P	PURPLE	0.630	0.866	1.220	2.087	16.0	22.0	31.0	53.0	100

Combined CONS & CONE Starter Kit Available.  
See page 107



## ■ 475°F (250°C)

■ EPSI's (CONE) EPDM CONE Cap product line is an economical alternative to the (CONS) Silicone CON Cap line.

■ Suitable for low temp powder coating, plating and anodizing.

■ Made of a rugged blend of our high temperature EPDM, these caps have excellent sealing characteristics, chemical resistance and reusability.

# EPDM CONE CAPS

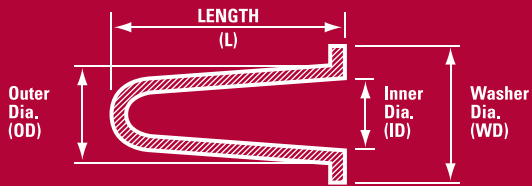

PART NUMBER	COLOR	ID (in)	STANDARD			METRIC				BOX QTY
			OD (in)	WD (in)	L (in)	ID (mm)	OD (mm)	WD (mm)	L (mm)	
CONE 00613-B	BLACK	0.130	0.250	0.500	0.906	3.3	6.4	12.7	23.0	500
CONE 00813-B	BLACK	0.216	0.316	0.500	1.000	5.5	8.0	12.7	25.4	50
CONE 00916-B	BLACK	0.177	0.335	0.625	1.000	4.5	8.5	15.9	25.4	500
CONE 01017-B	BLACK	0.197	0.394	0.650	1.102	5.0	10.0	16.5	28.0	500
CONE 01116-B	BLACK	0.230	0.400	0.635	1.100	5.8	10.2	16.1	27.9	250
CONE 01419-B	BLACK	0.315	0.551	0.750	1.417	8.0	14.0	19.1	36.0	250
CONE 01725-B	BLACK	0.453	0.689	0.980	1.500	11.5	17.5	24.9	38.1	250
CONE 02028-B	BLACK	0.532	0.767	1.100	2.009	13.5	19.5	27.9	51.0	100
CONE 02125-B	BLACK	0.583	0.819	1.000	1.929	14.8	20.8	25.4	49.0	100
CONE 02231-B	BLACK	0.630	0.866	1.220	2.087	16.0	22.0	31.0	53.0	100



866-ASK-EPSI (866-275-3774)  
866-FAX-EPSI (866-329-3774)

15

Order online at  
[www.epsi.com](http://www.epsi.com)

**YOU ASK IT.  
WE MASK IT.**

# EC EPDM Caps

475°F (250°C)



■ Can be Used as Both a Cap and Plug

■ EPDM Caps are Reusable and have Excellent Chemical Resistance

■ Round Top Profile Allows for Easy Insertion into Holes

■ Flexible Enough to Conform to Irregular Geometry

## TYPICAL INDUSTRIES USED

Powder Coating, E-Coating, Plating, Anodizing, Sand Blasting and Shipping Caps

## TYPICAL APPLICATIONS

Used as a cap over threaded studs, dowels, and protrusions. Used as a plug for tapped holes, irregular contours and threaded holes.



## PRODUCT DESCRIPTION

Our EPDM Cap (EC) product line is the industry standard for low cost masking applications. Their versatile nature allows them to fit over extrusions, threaded studs, PEMS and dowels, as well as be used as a plug for tapped holes, irregular contours and threaded holes. Our high temperature EPDM is specially formulated to resist chemical attack and ensure reusability and economy during masking.

## HELPFUL HINTS

- When sizing parts as a cap, the ID of the cap should be 2 - 3% smaller than the stud diameter.
- To ensure easy removal, select a cap length that is slightly longer than the masking length of the stud. This is especially important if the cap ID is less than 4% of the stud diameter.
- When sizing parts as a plug, the OD should be at least 6% larger than the hole diameter.
- If used to cover tube ends in powder coating, a small slit in the top of the cap will prevent blow-off. (See EZY™ Caps.)
- Economical enough to be used one time in high temperature applications, or where the cap will be used during shipping after coating process.



866-ASK-EPSI (866-275-3774)  
866-FAX-EPSI (866-329-3774)

16

Order online at  
[www.epsi.com](http://www.epsi.com)

**YOU ASK IT.  
WE MASK IT.®**



# EC SERIES

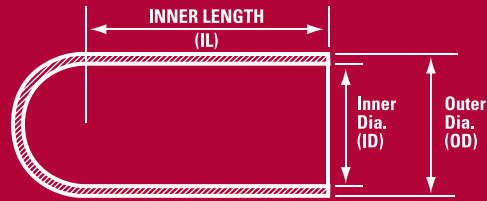

PART NUMBER	COLOR	STANDARD			METRIC			BOX QTY
		ID (in)	OD (in)	IL (in)	ID (mm)	OD (mm)	IL (mm)	
EC 0040X0750	BLACK	0.040	0.130	0.750	1.0	3.3	19.1	1000
EC 0062X0750	BLACK	0.062	0.152	0.750	1.6	3.9	19.1	1000
EC 0100X1000	BLACK	0.100	0.200	1.000	2.5	5.1	25.4	1000
EC 0109X0500	BLACK	0.109	0.229	0.500	2.8	5.8	12.7	1000
EC 0109X0750	BLACK	0.109	0.209	0.750	2.8	5.3	19.1	1000
EC 0125X0500	BLACK	0.125	0.225	0.500	3.2	5.7	12.7	1000
EC 0125X1000	BLACK	0.125	0.225	1.000	3.2	5.7	25.4	1000
EC 0140X1000	BLACK	0.140	0.260	1.000	3.6	6.6	25.4	1000
EC 0148X1000	BLACK	0.148	0.268	1.000	3.8	6.8	25.4	1000
EC 0156X0500	BLACK	0.156	0.276	0.500	4.0	7.0	12.7	1000
EC 0156X1000	BLACK	0.156	0.276	1.000	4.0	7.0	25.4	1000
EC 0172X0500	BLACK	0.172	0.292	0.500	4.4	7.4	12.7	1000
EC 0172X1000	BLACK	0.172	0.292	1.000	4.4	7.4	25.4	1000
EC 0180X1000	BLACK	0.180	0.300	1.000	4.6	7.6	25.4	1000
EC 0187X0500	BLACK	0.187	0.307	0.500	4.7	7.8	12.7	1000
EC 0187X1000	BLACK	0.187	0.307	1.000	4.7	7.8	25.4	1000
EC 0197X0500	BLACK	0.197	0.317	0.500	5.0	8.1	12.7	1000
EC 0218X1000	BLACK	0.218	0.338	1.000	5.5	8.6	25.4	1000
EC 0223X1000	BLACK	0.223	0.343	1.000	5.7	8.7	25.4	1000
EC 0223X1500	BLACK	0.223	0.343	1.500	5.7	8.7	38.1	1000
EC 0234X0500	BLACK	0.234	0.354	0.500	5.9	9.0	12.7	1000
EC 0234X0787	BLACK	0.234	0.354	0.787	5.9	9.0	20.0	1000
EC 0234X1000	BLACK	0.234	0.354	1.000	5.9	9.0	25.4	1000
EC 0234X1500	BLACK	0.234	0.354	1.500	5.9	9.0	38.1	1000
EC 0250X1000	BLACK	0.250	0.370	1.000	6.4	9.4	25.4	1000
EC 0295X0500	BLACK	0.295	0.415	0.500	7.5	10.5	12.7	500
EC 0295X0750	BLACK	0.295	0.415	0.750	7.5	10.5	19.1	500
EC 0295X1000	BLACK	0.295	0.415	1.000	7.5	10.5	25.4	500
EC 0295X1500	BLACK	0.295	0.415	1.500	7.5	10.5	38.1	500
EC 0312X1000	BLACK	0.312	0.432	1.000	7.9	11.0	25.4	500
EC 0312X1500	BLACK	0.312	0.432	1.500	7.9	11.0	38.1	500
EC 0340X1000	BLACK	0.340	0.460	1.000	8.6	11.7	25.4	500
EC 0355X1500	BLACK	0.355	0.475	1.500	9.0	12.1	38.1	500
EC 0366X1500	BLACK	0.366	0.486	1.500	9.3	12.3	38.1	500
EC 0375X1000	BLACK	0.375	0.495	1.000	9.5	12.6	25.4	500
EC 0375X1500	BLACK	0.375	0.495	1.500	9.5	12.6	38.1	500
EC 0437X1000	BLACK	0.437	0.557	1.000	11.1	14.1	25.4	250



866-ASK-EPSI (866-275-3774)  
866-FAX-EPSI (866-329-3774)

Order online at  
[www.epsi.com](http://www.epsi.com)



## EC SERIES

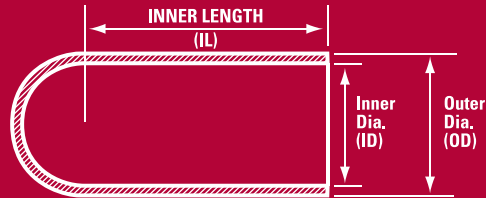

PART NUMBER	COLOR	STANDARD			METRIC			BOX QTY
		ID (in)	OD (in)	IL (in)	ID (mm)	OD (mm)	IL (mm)	
EC 0456X1500	BLACK	0.456	0.556	1.500	11.6	14.1	38.1	250
EC 0468X1000	BLACK	0.468	0.588	1.000	11.9	14.9	25.4	250
EC 0500X1500	BLACK	0.500	0.620	1.500	12.7	15.7	38.1	250
EC 0535X1500	BLACK	0.535	0.635	1.500	13.6	16.1	38.1	250
EC 0535X3000	BLACK	0.535	0.655	3.000	13.6	16.6	76.2	250
EC 0600X1500	BLACK	0.600	0.708	1.500	15.2	18.0	38.1	250
EC 0625X1500	BLACK	0.625	0.745	1.500	15.9	18.9	38.1	250
EC 0750X1500	BLACK	0.750	0.870	1.500	19.1	22.1	38.1	100
EC 0812X1500	BLACK	0.812	0.932	1.500	20.6	23.7	38.1	100
EC 0875X1500	BLACK	0.875	0.995	1.500	22.2	25.3	38.1	100
EC 1000X2000	BLACK	1.000	1.120	2.000	25.4	28.4	50.8	100
EC 1062X2000	BLACK	1.062	1.182	2.000	27.0	30.0	50.8	100
EC 1125X1500	BLACK	1.125	1.245	1.500	28.6	31.6	38.1	100
EC 1250X1500	BLACK	1.250	1.370	1.500	31.8	34.8	38.1	100
EC 1500X1750	BLACK	1.500	1.620	1.750	38.1	41.1	44.5	50
EC 1625X2000	BLACK	1.625	1.745	2.000	41.3	44.3	50.8	50
EC 1750X2000	BLACK	1.750	1.870	2.000	44.5	47.5	50.8	50
EC 1875X2000	BLACK	1.875	1.995	2.000	47.6	50.7	50.8	50
EC 2000X2000	BLACK	2.000	2.120	2.000	50.8	53.8	50.8	25

Starter Kit Available. See page 107



## Starter kit is a must for all design engineers!

■ Current pricing and additional sizes available at [www.epsi.com](http://www.epsi.com)



866-ASK-EPSI (866-275-3774)  
866-FAX-EPSI (866-329-3774)

18

Order online at  
[www.epsi.com](http://www.epsi.com)

**YOU ASK IT.  
WE MASK IT.**

# HSTS Hollow Stoppers

600°F (315°C)



■ Hollow Design Reduces Material and Shipping Cost

## PRODUCT DESCRIPTION

Our Hollow Silicone Tapered Stoppers (HSTS) are typically substituted for the same size solid tapered stopper due to their lower cost. With many sizes available, holes from 0.935" to 4.710" in diameter can easily be plugged. Our high temperature silicone is specially formulated to ensure reusability and reliability during masking.

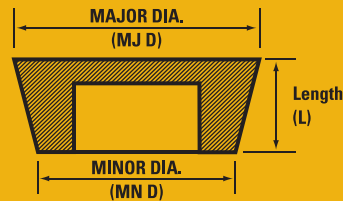

## HSTS SERIES

PART NUMBER	COLOR	STANDARD			METRIC			BOX QTY
		MJ D (in)	MN D (in)	L (in)	MJ D (mm)	MN D (mm)	L (mm)	
HSTS 1063-W	WHITE	1.063	0.905	1.000	27.0	23.0	25.4	100
HSTS 1102-F	RUSTY	1.102	0.945	1.000	28.0	24.0	25.4	100
HSTS 1260-L	YELLOW	1.260	1.024	1.000	32.0	26.0	25.4	100
HSTS 1338-Z	BROWN	1.338	1.063	1.000	34.0	27.0	25.4	100
HSTS 1456-U	BLUE	1.456	1.180	1.000	37.0	30.0	25.4	100
HSTS 1535-B	BLACK	1.535	1.220	1.000	39.0	31.0	25.4	50
HSTS 1614-R	RED	1.614	1.300	1.000	41.0	33.0	25.4	50
HSTS 1693-Y	GRAY	1.693	1.417	1.000	43.0	36.0	25.4	50
HSTS 1772-N	PINK	1.772	1.457	1.000	45.0	37.0	25.4	50
HSTS 1810-W	WHITE	1.810	1.496	1.000	46.0	38.0	25.4	50
HSTS 1968-F	RUSTY	1.968	1.653	1.000	50.0	42.0	25.4	50
HSTS 2086-G	GREEN	2.086	1.770	1.000	53.0	45.0	25.4	25
HSTS 2205-L	YELLOW	2.205	1.890	1.000	56.0	48.0	25.4	25
HSTS 2480-Z	BROWN	2.480	1.968	1.000	63.0	50.0	25.4	25
HSTS 2520-U	BLUE	2.520	2.125	1.000	64.0	54.0	25.4	25
HSTS 2677-F	RUSTY	2.677	2.283	1.000	68.0	58.0	25.4	25
HSTS 2953-R	RED	2.953	2.440	1.377	75.0	62.0	35.0	25
HSTS 3543-Y	GRAY	3.543	2.953	1.535	90.0	75.0	39.0	10
HSTS 4055-N	PINK	4.055	3.267	1.535	103.0	83.0	39.0	10
HSTS 4750-C	CLEAR	4.750	3.543	3.423	120.7	90.0	86.9	5
HSTS 5000-W	WHITE	5.000	3.543	1.968	127.0	90.0	50.0	5

■ Current pricing and additional sizes available at [www.epsi.com](http://www.epsi.com)



866-ASK-EPSI (866-275-3774)  
866-FAX-EPSI (866-329-3774)

19

Order online at  
[www.epsi.com](http://www.epsi.com)

**YOU ASK IT.  
WE MASK IT.®**

# STS Silicone Tapered Stoppers

600°F (315°C)



■ Tapered Design to Fit a Variety of Hole Diameters

■ Compressible for Better Sealing of Both Threaded and Non-Threaded Holes

## TYPICAL INDUSTRIES USED

Powder Coating, E-Coating, Plating and Anodizing

## TYPICAL APPLICATIONS

Used as a plug in both threaded and non-threaded holes and in combination with hardware to seal off large cavities.

## HELPFUL HINTS

- Make sure that the major diameter of the plug is at least 15% larger than the hole diameter.
- The minor diameter should be at least 15% smaller than the hole diameter.



- When masking off both the front and back of a cavity, it is possible to combine two (STS) with hardware to create a liquid tight mask that resists blow-out. Call for details.

- Silicone Tapered Stoppers are not recommended for exposure to aggressive chemicals or hydrocarbons.

## PRODUCT DESCRIPTION

Our Silicone Tapered Stopper (STS) product line is an industry standard for general plugging applications. With many sizes available, holes from 0.020" to 4.710" in diameter can easily be plugged. Our high temperature silicone is specially formulated to ensure reusability and reliability during masking.

Starter Kit Available.  
See page 107



866-ASK-EPSI (866-275-3774)  
866-FAX-EPSI (866-329-3774)

20

Order online at  
[www.epsi.com](http://www.epsi.com)

**YOU ASK IT.  
WE MASK IT.®**



# STS SERIES

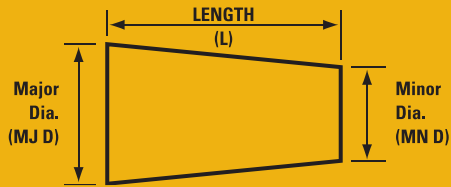

PART NUMBER	REF #	COLOR	STANDARD			METRIC			BOX QTY
			MJ D (in)	MN D (in)	L (in)	MJ D (mm)	MN D (mm)	L (mm)	
STS 0062X0625-B		BLACK	0.062	0.016	0.625	1.6	0.4	15.9	1000
STS 0078X1000-U		BLUE	0.078	0.020	1.000	2.0	0.5	25.4	1000
STS 0100X0625-L	99	YELLOW	0.100	0.031	0.625	2.5	0.8	15.9	1000
STS 0100X1000-L		YELLOW	0.100	0.031	1.000	2.5	0.8	25.4	1000
STS 0125X0625-N	100	PINK	0.125	0.062	0.625	3.2	1.6	15.9	1000
STS 0177X0591-P		PURPLE	0.177	0.060	0.591	4.5	1.5	15.0	1000
STS 0187X0394-C		CLEAR	0.187	0.109	0.394	4.7	2.8	10.0	1000
STS 0187X0625-W	101	WHITE	0.187	0.062	0.625	4.7	1.6	15.9	1000
STS 0187X0750-F	101L	RUSTY	0.187	0.062	0.750	4.7	1.6	19.1	1000
STS 0188X2200-Y		GRAY	0.188	0.047	2.200	4.8	1.2	55.9	1000
STS 0197X1100-G		GREEN	0.197	0.049	1.100	5.0	1.2	27.9	1000
STS 0200X0750-U		BLUE	0.200	0.062	0.750	5.1	1.6	19.1	1000
STS 0216X1500-N		PINK	0.216	0.047	1.500	5.5	1.2	38.1	1000
STS 0250X0750-G	102	GREEN	0.250	0.125	0.750	6.4	3.2	19.1	1000
STS 0250X1000-F	102L	RUSTY	0.250	0.125	1.000	6.4	3.2	25.4	1000
STS 0276X0787-L		YELLOW	0.276	0.118	0.787	7.0	3.0	20.0	1000
STS 0315X0787-R		RED	0.315	0.157	0.787	8.0	4.0	20.0	1000
STS 0343X0625-U	103	BLUE	0.343	0.187	0.625	8.7	4.7	15.9	1000
STS 0343X1000-F	103L	RUSTY	0.343	0.187	1.000	8.7	4.7	25.4	1000
STS 0354X0984-I		IVORY	0.354	0.177	0.984	9.0	4.5	25.0	1000
STS 0375X0500-L	105	YELLOW	0.375	0.250	0.500	9.5	6.4	12.7	500
STS 0375X0750-L	104	YELLOW	0.375	0.250	0.750	9.5	6.4	19.1	500
STS 0375X1250-L		YELLOW	0.375	0.125	1.250	9.5	3.2	31.8	500
STS 0393X0787-U		BLUE	0.393	0.236	0.787	10.0	6.0	20.0	500
STS 0394X1890-W		WHITE	0.394	0.197	1.890	10.0	5.0	48.0	500
STS 0433X1063-G		GREEN	0.433	0.315	1.063	11.0	8.0	27.0	500
STS 0437X1000-F	104L	RUSTY	0.437	0.250	1.000	11.1	6.4	25.4	500
STS 0438X0688-B	106	BLACK	0.438	0.344	0.688	11.1	8.7	17.5	500
STS 0472X0748-R		RED	0.472	0.354	0.748	12.0	9.0	19.0	500
STS 0473X0787-Y		GRAY	0.473	0.312	0.787	12.0	7.9	20.0	500
STS 0487X0748-C		CLEAR	0.487	0.354	0.748	12.4	9.0	19.0	500
STS 0500X0813-Z	000	BROWN	0.500	0.313	0.813	12.7	8.0	20.7	250
STS 0500X1000-Z		BROWN	0.500	0.312	1.000	12.7	7.9	25.4	250
STS 0500X2000-Z		BROWN	0.500	0.125	2.000	12.7	3.2	50.8	250
STS 0512X0984-B		BLACK	0.512	0.354	0.984	13.0	9.0	25.0	250
STS 0562X1125-F		RUSTY	0.562	0.313	1.125	14.3	8.0	28.6	250
STS 0563X1000-U	107	BLUE	0.563	0.375	1.000	14.3	9.5	25.4	250
STS 0590X1000-P	00	PURPLE	0.590	0.393	1.000	15.0	10.0	25.4	250
STS 0591X0787-Z		BROWN	0.591	0.433	0.787	15.0	11.0	20.0	250
STS 0625X0813-G	108	GREEN	0.625	0.437	0.813	15.9	11.1	20.7	250
STS 0656X1000-C		CLEAR	0.656	0.500	1.000	16.7	12.7	25.4	250

■ Current pricing and additional sizes available at [www.epsi.com](http://www.epsi.com)



866-ASK-EPSI (866-275-3774)  
866-FAX-EPSI (866-329-3774)

21

Order online at  
[www.epsi.com](http://www.epsi.com)



# STS SERIES

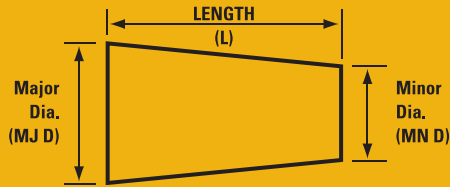

PART NUMBER	REF #	COLOR	STANDARD			METRIC			BOX QTY
			MJ D (in)	MN D (in)	L (in)	MJ D (mm)	MN D (mm)	L (mm)	
STS 0669X1000-R	0	RED	0.669	0.510	1.000	17.0	13.0	25.4	250
STS 0687X1000-R		CLEAR	0.687	0.437	1.000	17.4	11.1	25.4	250
STS 0709X0787-C		CLEAR	0.709	0.551	0.787	18.0	14.0	20.0	250
STS 0748X1000-B	1	BLACK	0.748	0.550	1.000	19.0	14.0	25.4	250
STS 0787X1000-R	2	RED	0.787	0.630	1.000	20.0	16.0	25.4	100
STS 0812X1000-C		CLEAR	0.812	0.625	1.000	20.6	15.9	25.4	100
STS 0827X0984-R		RED	0.827	0.630	0.984	21.0	16.0	25.0	100
STS 0925X1000-C		CLEAR	0.925	0.750	1.000	23.5	19.1	25.4	100
STS 0938X1000-L	3	YELLOW	0.938	0.708	1.000	23.8	18.0	25.4	100
STS 0945X0750-B		BLACK	0.945	0.756	0.750	24.0	19.2	19.1	100
STS 0946X1181-C		CLEAR	0.946	0.709	1.181	24.0	18.0	30.0	100
STS 0984X0885-C		CLEAR	0.984	0.787	0.885	25.0	20.0	22.5	100
STS 0990X0795-C		CLEAR	0.990	0.880	0.795	25.1	22.4	20.2	100
STS 1024X1000-C	4	CLEAR	1.024	0.787	1.000	26.0	20.0	25.4	100
STS 1062X0984-C		CLEAR	1.062	0.866	0.984	27.0	22.0	25.0	100
STS 1063X1000-C	5	CLEAR	1.063	0.905	1.000	27.0	23.0	25.4	100
STS 1102X1000-C	5.5	CLEAR	1.102	0.945	1.000	28.0	24.0	25.4	100
STS 1102X2000-C		CLEAR	1.102	0.750	2.000	28.0	19.1	50.8	100
STS 1220X1181-C		CLEAR	1.220	0.984	1.181	31.0	25.0	30.0	100
STS 1260X1000-C	6	CLEAR	1.260	1.024	1.000	32.0	26.0	25.4	100
STS 1325X0835-C		CLEAR	1.325	1.140	0.835	33.7	29.0	21.2	100
STS 1338X1000-C	6.5	CLEAR	1.338	1.063	1.000	34.0	27.0	25.4	100
STS 1375X1000-C		CLEAR	1.375	1.180	1.000	34.9	30.0	25.4	100
STS 1456X1000-C	7	CLEAR	1.456	1.180	1.000	37.0	30.0	25.4	100
STS 1535X1000-C	7.5	CLEAR	1.535	1.220	1.000	39.0	31.0	25.4	50
STS 1614X1000-C	8	CLEAR	1.614	1.300	1.000	41.0	33.0	25.4	50
STS 1693X1000-C	8.5	CLEAR	1.693	1.417	1.000	43.0	36.0	25.4	50
STS 1732X1575-C		CLEAR	1.732	1.417	1.575	44.0	36.0	40.0	50
STS 1772X1000-C	9	CLEAR	1.772	1.457	1.000	45.0	37.0	25.4	50
STS 1810X1000-C	9.5	CLEAR	1.810	1.496	1.000	46.0	38.0	25.4	50
STS 1968X1000-C	10	CLEAR	1.968	1.653	1.000	50.0	42.0	25.4	50
STS 2086X1000-C	10.5	CLEAR	2.086	1.770	1.000	53.0	45.0	25.4	25
STS 2205X1000-C	11	CLEAR	2.205	1.890	1.000	56.0	48.0	25.4	25
STS 2362X1772-C		CLEAR	2.362	1.969	1.772	60.0	50.0	45.0	25
STS 2480X1000-C	11.5	CLEAR	2.480	1.968	1.000	63.0	50.0	25.4	25
STS 2520X1000-C	12	CLEAR	2.520	2.125	1.000	64.0	54.0	25.4	25
STS 2677X1000-C	13	CLEAR	2.677	2.283	1.000	68.0	58.0	25.4	25
STS 2953X1377-C	13.5	CLEAR	2.953	2.440	1.377	75.0	62.0	35.0	25
STS 3543X1535-C	14	CLEAR	3.543	2.953	1.535	90.0	75.0	39.0	10
STS 4055X1535-C	15	CLEAR	4.055	3.267	1.535	103.0	83.0	39.0	10
STS 5000X1968-C	16	CLEAR	5.000	3.543	1.968	127.0	90.0	50.0	5

■ Current pricing and additional sizes available at [www.epsi.com](http://www.epsi.com)



866-ASK-EPSI (866-275-3774)  
866-FAX-EPSI (866-329-3774)

Order online at [www.epsi.com](http://www.epsi.com)



# BES Black EPDM Stoppers

475°F (250°C)



- Tapered to Fit a Variety of Hole Diameters
- Compressible for Better Sealing of Both Threaded and Non-threaded Holes
- Ideal for Sand Blasting
- Excellent Chemical and Hydrocarbon Resistance

## TYPICAL INDUSTRIES USED

Powder Coating, E-Coating, Plating, Anodizing and Shot Blasting

## TYPICAL APPLICATIONS

Used as a plug in both threaded and non-threaded holes and in combination with hardware to seal off large cavities.

## HELPFUL HINTS

- Make sure that the major diameter of the plug is at least 15% larger than the hole diameter.

- The minor diameter should be at least 15% smaller than the hole diameter.
- EPDM Tapered Stoppers are not recommended for prolonged exposure to intense heat.

## PRODUCT DESCRIPTION

Our Black EPDM Stopper (BES) product line is an economical substitute for our STS product line for general plugging applications. With many sizes available, holes from 0.020" to 4.710" in diameter can easily be plugged. Our high temperature EPDM is specially formulated to resist chemical attack and ensure reusability and economy during masking.



866-ASK-EPSI (866-275-3774)  
866-FAX-EPSI (866-329-3774)

23

Order online at  
[www.epsi.com](http://www.epsi.com)

**YOU ASK IT.  
WE MASK IT.®**

# BES SERIES

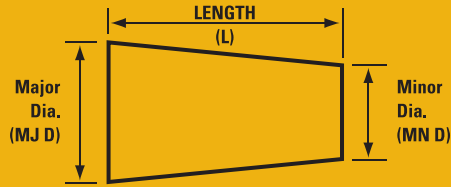

PART NUMBER	REF #	STANDARD			METRIC			BOX QTY
		MJ D (in)	MN D (in)	L (in)	MJ D (mm)	MN D (mm)	L (mm)	
BES 0100X0625	99	0.100	0.031	0.625	2.5	0.8	15.9	1000
BES 0125X0625	100	0.125	0.062	0.625	3.2	1.6	15.9	1000
BES 0187X0625	101	0.187	0.062	0.625	4.7	1.6	15.9	1000
BES 0187X0750	101L	0.187	0.062	0.750	4.7	1.6	19.1	1000
BES 0197X1100		0.197	0.049	1.100	5.0	1.2	27.9	1000
BES 0200X0750		0.200	0.062	0.750	5.1	1.6	19.1	1000
BES 0216X1500		0.216	0.047	1.500	5.5	1.2	38.1	1000
BES 0250X0750	102	0.250	0.125	0.750	6.4	3.2	19.1	1000
BES 0250X1000	102L	0.250	0.125	1.000	6.4	3.2	25.4	1000
BES 0343X0625	103	0.343	0.187	0.625	8.7	4.7	15.9	1000
BES 0343X1000	103L	0.343	0.187	1.000	8.7	4.7	25.4	1000
BES 0375X0500		0.375	0.250	0.500	9.5	6.4	12.7	500
BES 0375X0750	104	0.375	0.250	0.750	9.5	6.4	19.1	500
BES 0375X1250		0.375	0.125	1.250	9.5	3.2	31.8	500
BES 0394X1890		0.394	0.197	1.890	10.0	5.0	48.0	500
BES 0437X1000	104L	0.437	0.250	1.000	11.1	6.4	25.4	500
BES 0438X0688	106	0.438	0.344	0.688	11.1	8.7	17.5	500
BES 0500X0813	000	0.500	0.313	0.813	12.7	8.0	20.7	250
BES 0500X1000		0.500	0.312	1.000	12.7	7.9	25.4	250
BES 0563X1000	107	0.563	0.375	1.000	14.3	9.5	25.4	250
BES 0590X1000	00	0.590	0.393	1.000	15.0	10.0	25.4	250
BES 0625X0813	108	0.625	0.437	0.813	15.9	11.1	20.7	250
BES 0656X1000		0.656	0.500	1.000	16.7	12.7	25.4	250
BES 0669X1000	0	0.669	0.510	1.000	17.0	13.0	25.4	250
BES 0687X1000		0.687	0.437	1.000	17.4	11.1	25.4	250
BES 0748X1000	1	0.748	0.550	1.000	19.0	14.0	25.4	250
BES 0812X1000		0.812	0.625	1.000	20.6	15.9	25.4	100
BES 0938X1000	3	0.938	0.708	1.000	23.8	18.0	25.4	100
BES 1024X1000	4	1.024	0.787	1.000	26.0	20.0	25.4	100
BES 1063X1000	5	1.063	0.905	1.000	27.0	23.0	25.4	100
BES 1102X1000	5.5	1.102	0.945	1.000	28.0	24.0	25.4	100
BES 1220X1181		1.220	0.984	1.181	31.0	25.0	30.0	100
BES 1260X1000	6	1.260	1.024	1.000	32.0	26.0	25.4	100
BES 1338X1000	6.5	1.338	1.063	1.000	34.0	27.0	25.4	100
BES 1456X1000	7	1.456	1.180	1.000	37.0	30.0	25.4	100
BES 1535X1000	75	1.535	1.220	1.000	39.0	31.0	25.4	50

■ Current pricing and additional sizes available at [www.epsi.com](http://www.epsi.com)



866-ASK-EPSI (866-275-3774)  
866-FAX-EPSI (866-329-3774)

24

Order online at  
[www.epsi.com](http://www.epsi.com)



# BES SERIES

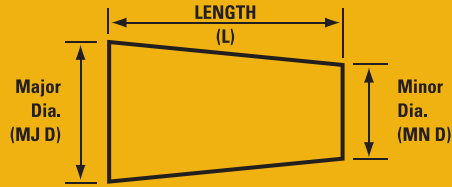

PART NUMBER	REF #	STANDARD			METRIC			BOX QTY
		MJ D (in)	MN D (in)	L (in)	MJ D (mm)	MN D (mm)	L (mm)	
BES 1614X1000	8	1.614	1.300	1.000	41.0	33.0	25.4	50
BES 1693X1000	8.5	1.693	1.417	1.000	43.0	36.0	25.4	50
BES 1772X1000	9	1.772	1.457	1.000	45.0	37.0	25.4	50
BES 1810X1000	9.5	1.810	1.496	1.000	46.0	38.0	25.4	50
BES 1968X1000	10	1.968	1.653	1.000	50.0	42.0	25.4	50
BES 2086X1000	10.5	2.086	1.770	1.000	53.0	45.0	25.4	25
BES 2205X1000	11	2.205	1.890	1.000	56.0	48.0	25.4	25
BES 2480X1000	11.5	2.480	1.968	1.000	63.0	50.0	25.4	25
BES 2520X1000	12	2.520	2.125	1.000	64.0	54.0	25.4	25
BES 2677X1000	13	2.677	2.283	1.000	68.0	58.0	25.4	25
BES 2953X1377	13.5	2.953	2.440	1.377	75.0	62.0	35.0	25
BES 3543X1535	14	3.543	2.953	1.535	90.0	75.0	39.0	10
BES 4055X1535	15	4.055	3.267	1.535	103.0	83.0	39.0	10

■ Current pricing and additional sizes available at [www.epsi.com](http://www.epsi.com)

Starter Kit Available. See page 108



866-ASK-EPSI (866-275-3774)  
866-FAX-EPSI (866-329-3774)

25

Order online at [www.epsi.com](http://www.epsi.com)

**YOU ASK IT.  
WE MASK IT.**



# CRKR Cork Stoppers

300°F (150°C)



- Tapered to Fit a Variety of Hole Diameters
- Economical Cork Material is Ideal for Wet Paint and Shipping Applications

## PRODUCT DESCRIPTION

Our Cork Stopper (CRKR) product line is an economical solution for wet spray applications and low temp powder coating or where it is necessary to leave the plug in for shipping. With many sizes available, holes from 0.120" to 2.125" in diameter can easily be plugged.

## HELPFUL HINTS

- Make sure that the major diameter of the plug is at least 15% larger than the hole diameter.
- The minor diameter should be at least 15% smaller than the hole diameter.
- Cork Stoppers can be easily cut for shallow cavities.

Starter Kit Available.  
See page 112



## CRKR SERIES

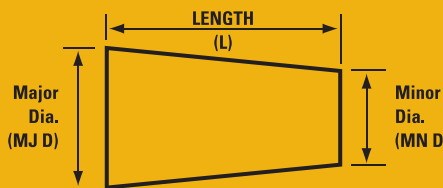

PART NUMBER	REF #	GRADE	STANDARD			METRIC			BOX QTY
			MJ D (in)	MN D (in)	L (in)	MJ D (mm)	MN D (mm)	L (mm)	
CRKR 0189	0000	XXX/XX	0.189	0.094	0.500	4.8	2.4	12.7	1000
CRKR 0248	000	XXX/XX	0.248	0.157	0.500	6.3	4.0	12.7	1000
CRKR 0311	00	XXX/XX	0.311	0.217	0.500	7.9	5.5	12.7	1000
CRKR 0374	0	XXX/XX	0.374	0.280	0.500	9.5	7.1	12.7	1000
CRKR 0437	1	XX/X	0.437	0.327	0.626	11.1	8.3	15.9	500
CRKR 0500	2	XX/X	0.500	0.378	0.689	12.7	9.6	17.5	250
CRKR 0563	3	XX/X	0.563	0.436	0.748	14.3	18.7	19.0	250
CRKR 0626	4	XX/X	0.626	0.469	0.811	15.9	11.9	20.6	250
CRKR 0689	5	XX/X	0.689	0.531	0.874	17.5	13.5	22.2	250
CRKR 0799	7	XX/X	0.799	0.626	1.000	20.3	15.9	25.4	100
CRKR 0874	8	XX/X	0.874	0.673	1.063	22.2	17.1	27.0	100
CRKR 0937	9	XX/X	0.937	0.732	1.126	23.8	18.6	28.6	100
CRKR 1000	10	XX/X	1.000	0.764	1.252	25.4	19.4	31.8	100

■ Current pricing and additional sizes available at [www.epsi.com](http://www.epsi.com)



866-ASK-EPSI (866-275-3774)  
866-FAX-EPSI (866-329-3774)

26

Order online at  
[www.epsi.com](http://www.epsi.com)

**YOU ASK IT.  
WE MASK IT.**

# FLPS/FLPE Flangeless Stoppers

600°F (315°C)



■ Tapered Ribs and Hollow Core Allow for Masking of Multiple Sizes of Holes

■ Sharp Rib Profile Offers Excellent Chamfer Coverage

■ Specially Formulated to be Rigid, Allowing Plug to be Pushed into Place

## TYPICAL INDUSTRIES USED

Powder Coating, E-Coating, Plating and Anodizing

## TYPICAL APPLICATIONS

Used as a plug for threaded holes, including the top thread.

## HELPFUL HINTS

- Silicone Flangeless Plugs are designed to be inserted via direct pressure. EPSI does not recommend threading these plugs into place, as threading may cause damage to the plug and difficulty during removal.

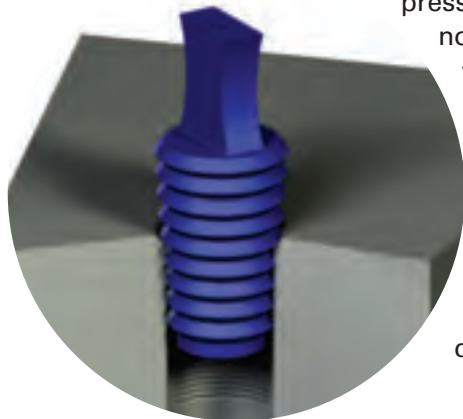

- Due to the low tear resistance of Silicone, do not use tools (such as pliers) to remove plugs.

## PRODUCT DESCRIPTION

EPSI's Flangeless Plug (FLPS or FLPE) product line is specifically designed to mask threaded holes, including the top thread, without masking the surrounding area. The tapered ribs and hollow core allow for many different size holes to be masked, regardless of the thread pitch. Imitation plugs have rounded ribs that do not offer the same degree of protection as EPSI's FLPS line. Made of a rugged blend of our High Temperature Silicone the FLPS has excellent sealing characteristics and reusability.



866-ASK-EPSI (866-275-3774)  
866-FAX-EPSI (866-329-3774)

27

Order online at  
[www.epsi.com](http://www.epsi.com)

**YOU ASK IT.  
WE MASK IT.®**

# SILICONE FLANGELESS PLUGS

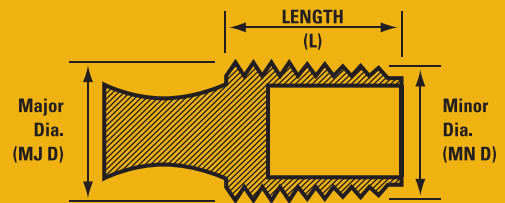

PART NUMBER	COLOR	STANDARD			METRIC			BOX QTY
		MJ D (in)	MN D (in)	L (in)	MJ D (mm)	MN D (mm)	L (mm)	
FLPS 00402-N	PINK	0.157	0.079	0.748	4.0	2.0	19.0	500
FLPS 00604-C	CLEAR	0.236	0.157	1.000	6.0	4.0	25.4	250
FLPS 00806-Y	GRAY	0.315	0.236	1.000	8.0	6.0	25.4	250
FLPS 01008-F	RUSTY	0.394	0.315	1.000	10.0	8.0	25.4	250
FLPS 01210-U	BLUE	0.472	0.394	1.000	12.0	10.0	25.4	250
FLPS 01412-C	CLEAR	0.551	0.472	1.000	14.0	12.0	25.4	250
FLPS 01614-Y	GRAY	0.630	0.551	1.000	16.0	14.0	25.4	250
FLPS 01816-F	RUSTY	0.709	0.630	1.000	18.0	16.0	25.4	250
FLPS 02018-U	BLUE	0.787	0.709	1.000	20.0	18.0	25.4	100
FLPS 02220-C	CLEAR	0.886	0.787	1.000	22.5	20.0	25.4	100
FLPS 02422-Y	GRAY	0.945	0.886	1.000	24.0	22.5	25.4	100
FLPS 02624-F	RUSTY	1.024	0.945	1.000	26.0	24.0	25.4	100
FLPS 02826-U	BLUE	1.102	1.024	1.000	28.0	26.0	25.4	100

Starter Kit Available for both FLPS & FLPE. See pages 108 & 109



## ■ 475°F (250°C)

■ EPSI's EPDM Flangeless Plug (FLPE) product line is an economical alternative to the Silicone Flangeless Plug (FLPS) line.

■ Made of a rugged blend of our High Temperature EPDM the FLPE has excellent sealing characteristics, chemical resistance and reusability.

# EPDM FLANGELESS PLUGS

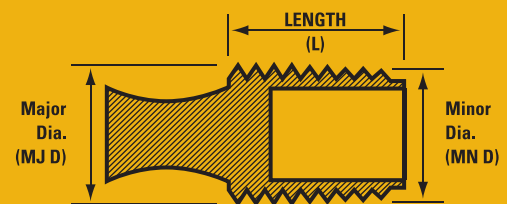

PART NUMBER	COLOR	STANDARD			METRIC			BOX QTY
		MJ D (in)	MN D (in)	L (in)	MJ D (mm)	MN D (mm)	L (mm)	
FLPE 00402-B	BLACK	0.157	0.079	0.748	4.0	2.0	19.0	500
FLPE 00604-B	BLACK	0.236	0.157	1.000	6.0	4.0	25.4	250
FLPE 00806-B	BLACK	0.315	0.236	1.000	8.0	6.0	25.4	250
FLPE 01008-B	BLACK	0.394	0.315	1.000	10.0	8.0	25.4	250
FLPE 01210-B	BLACK	0.472	0.394	1.000	12.0	10.0	25.4	250
FLPE 01412-B	BLACK	0.551	0.472	1.000	14.0	12.0	25.4	250
FLPE 01614-B	BLACK	0.630	0.551	1.000	16.0	14.0	25.4	250
FLPE 01816-B	BLACK	0.709	0.630	1.000	18.0	16.0	25.4	250
FLPE 02018-B	BLACK	0.787	0.709	1.000	20.0	18.0	25.4	100
FLPE 02220-B	BLACK	0.886	0.787	1.000	22.5	20.0	25.4	100
FLPE 02422-B	BLACK	0.945	0.886	1.000	24.0	22.5	25.4	100
FLPE 02624-B	BLACK	1.024	0.945	1.000	26.0	24.0	25.4	100
FLPE 02826-B	BLACK	1.102	1.024	1.000	28.0	26.0	25.4	100
FLPE 03229-B	BLACK	1.250	1.125	1.000	32.0	28.6	25.4	100

■ Current pricing and additional sizes available at [www.epsi.com](http://www.epsi.com)



866-ASK-EPSI (866-275-3774)  
866-FAX-EPSI (866-329-3774)

Order online at [www.epsi.com](http://www.epsi.com)



# SMS Silicone Masking Stopper

600°F (315°C)



## PRODUCT DESCRIPTION

- Secures masking affected by pressure buildup.
- Eliminates "pop-out" and rejected parts.
- Allows a "mix & match" of sizes for specific needs
- Easily combines with custom-designed parts for one or both ends.
- Provides multiple combinations for "solutions" on "the fly."

## SILICONE MASKING STOPPER

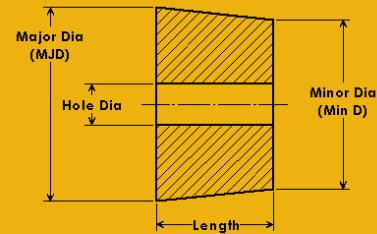

PART NUMBER	COLOR	SIZE
SMS 0750	Clear	0.855x0.645X1000
SMS 1050	Clear	1.155x0.945X1000
SMS 1250	Clear	1.355X1.14 X1000
SMS 1350	Clear	1.455X1.245X1000
SMS 1550	Clear	1.655X1.445X1000
SMS 2050	Clear	2.155X1.945X1000
SMS 2150	Clear	2.255X2.045X1000
SMS 2550	Clear	2.655X2.445X1000
SMS 3050	Clear	3.155X2.945X1000
SMS 3550	Clear	3.655X3.445X1000



## SILICONE MASKING STEM (TOMS STYLE STEM TSS)

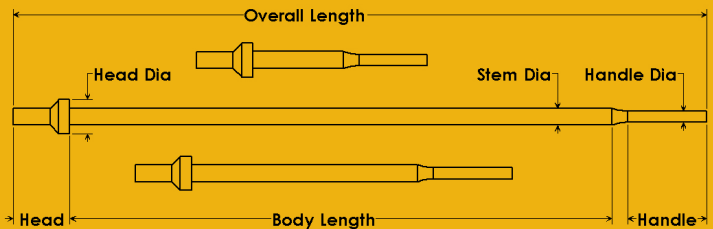

PART NUMBER	COLOR	SIZE
E 10453-B	Yellow	0375X5000 .375" STEM X 5"X.75" DIA HEAD
E 12282-SO	Orange	0375X2000 .380" STEM X 2"X.75" DIA HEAD
E12571-SG	Green	0375X12000 .375" STEM X 12.00" LONG



866-ASK-EPSI (866-275-3774)  
866-FAX-EPSI (866-329-3774)

29

Order online at  
[www.epsi.com](http://www.epsi.com)

**YOU ASK IT.  
WE MASK IT.**

# Washer Plugs

600°F (315°C)



- Tapered Design for Easy Insertion
- Washer Masks Grounding Area Around Holes
- One Plug can be Used to Plug Two Different Hole Diameters
- Second Plug Acts as Handle

## PRODUCT DESCRIPTION

Our Washer Plug (WP) sizes are conveniently grouped first by washer diameter, and then by the larger plug diameter. Many other combinations are possible. If you don't see the size you need listed, call an EPSI representative for other options.

## TYPICAL INDUSTRIES USED

Powder Coating, E-Coating, Plating and Anodizing

## TYPICAL APPLICATIONS

Plugging threaded and non-threaded blind holes with grounding area. Powder coated banjo connectors.

## HELPFUL HINTS

- When plugging a hole, make sure that the major diameter of the plug is 2-4% larger than the diameter of the hole.
- Twisting the plug as it is inserted, will aid in installation.
- Silicone plugs are not recommended for exposure to aggressive chemicals or hydrocarbons.

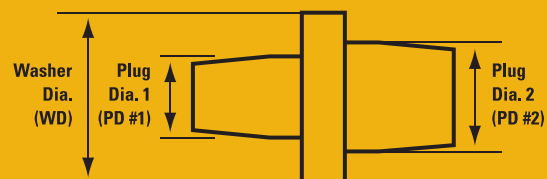

## WP SERIES

PART NUMBER	STANDARD			METRIC			BOX QTY
	WD (in)	PD#1 (in)	PD#2 (in)	WD (mm)	PD#1 (mm)	PD#2 (mm)	
WP103-250-130	0.250	0.103	0.130	6.4	2.6	3.3	1000
WP130-250-140	0.250	0.130	0.140	6.4	3.3	3.6	1000
WP130-250-200	0.250	0.130	0.200	6.4	3.3	5.1	1000
WP140-250-180	0.250	0.140	0.180	6.4	3.6	4.6	1000
WP155-250-200	0.250	0.155	0.200	6.4	3.9	5.1	1000
WP155-250-238	0.250	0.155	0.238	6.4	3.9	6.0	1000
WP180-250-180	0.250	0.180	0.180	6.4	4.6	4.6	1000
WP200-250-238	0.250	0.200	0.238	6.4	5.1	6.0	1000



866-ASK-EPSI (866-275-3774)  
866-FAX-EPSI (866-329-3774)

30

Order online at  
[www.epsi.com](http://www.epsi.com)

**YOU ASK IT.  
WE MASK IT.®**



# WP SERIES

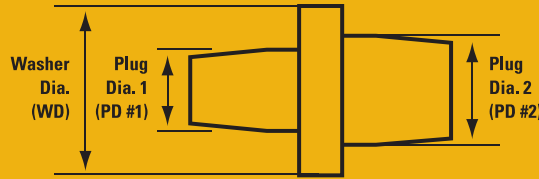

PART NUMBER	STANDARD			METRIC			BOX QTY
	WD (in)	PD#1 (in)	PD#2 (in)	WD (mm)	PD#1 (mm)	PD#2 (mm)	
WP130-312-155	0.312	0.130	0.155	7.9	3.3	3.9	1000
WP155-312-238	0.312	0.155	0.238	7.9	3.9	6.0	1000
WP200-312-238	0.312	0.200	0.238	7.9	5.1	6.0	1000
WP200-312-275	0.312	0.200	0.275	7.9	5.1	7.0	1000
WP180-350-225	0.350	0.180	0.225	8.9	4.6	5.7	500
WP140-375-200	0.375	0.140	0.200	9.5	3.6	5.1	500
WP155-375-238	0.375	0.155	0.238	9.5	3.9	6.0	500
WP180-375-200	0.375	0.180	0.200	9.5	4.6	5.1	500
WP200-375-275	0.375	0.200	0.275	9.5	5.1	7.0	500
WP209-375-275	0.375	0.209	0.275	9.5	5.3	7.0	500
WP238-375-250	0.375	0.238	0.250	9.5	6.0	6.4	500
WP275-375-375	0.375	0.275	0.375	9.5	7.0	9.5	500
WP130-500-375	0.500	0.130	0.375	12.7	3.3	9.5	250
WP140-500-180	0.500	0.140	0.180	12.7	3.6	4.6	250
WP155-500-390	0.500	0.155	0.390	12.7	3.9	9.9	250
WP180-500-200	0.500	0.180	0.200	12.7	4.6	5.1	250
WP180-500-238	0.500	0.180	0.238	12.7	4.6	6.0	250
WP238-500-250	0.500	0.238	0.250	12.7	6.0	6.4	250
WP275-500-375	0.500	0.275	0.375	12.7	7.0	9.5	250
WP350-500-420	0.500	0.350	0.420	12.7	8.9	10.7	250
WP390-500-455	0.500	0.390	0.455	12.7	9.9	11.6	250
WP140-625-250	0.625	0.140	0.250	15.9	3.6	6.4	250
WP346-625-413	0.625	0.346	0.413	15.9	8.8	10.5	250
WP218-716-281	0.716	0.218	0.281	18.2	5.5	7.1	100
WP331-787-331	0.787	0.331	0.331	20.0	8.4	8.4	100
WP375-787-512	0.787	0.375	0.512	20.0	9.5	13.0	100
WP551-787-551	0.787	0.551	0.551	20.0	14.0	14.0	100
WP551-787-689	0.787	0.551	0.689	20.0	14.0	17.5	100
WP551-944-708	0.944	0.551	0.708	24.0	18.0	14.0	100
WP265-1180-515	1.180	0.265	0.515	30.0	6.7	13.1	50
WP265-1180-640	1.180	0.265	0.640	30.0	6.7	16.3	50

■ Washer Plug sizes are conveniently grouped first by washer diameter, and then by the larger plug diameter.

■ Thousands of variations possible.

Starter Kit Available. See page 109

■ Current pricing and additional sizes available at [www.epsi.com](http://www.epsi.com)



866-ASK-EPSI (866-275-3774)  
866-FAX-EPSI (866-329-3774)

Order online at [www.epsi.com](http://www.epsi.com)



# TIPS Tube Insert Plugs

600°F (315°C)



- Plugging of Tube and Pipe Ends
- Flat Washer Will Cover Only the Tube End
- U-Channel Washer can Extend Over Tube End
- Well Suited for Liquid Tight Seal, and Resistance to Blowout



## PRODUCT DESCRIPTION

Our Tube Insert Plugs (TIPS) are an inexpensive alternative to stoppers. Especially well suited as a liquid tight seal when a large plug diameter is compressed into a small hole. The design of the TIPS resists blowout when compared to a tapered stopper.

## HELPFUL HINTS

- When plugging a hole, make sure that the major diameter of the plug is at least 10% larger than the diameter of the hole being plugged.

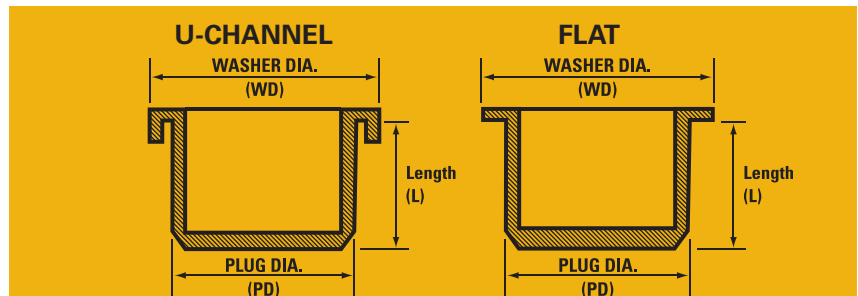

## TIPS SERIES

PART NUMBER	COLOR	STYLE	STANDARD			METRIC			BOX QTY
			PD (in)	WD (in)	L (in)	PD (mm)	WD (mm)	L (mm)	
TIPS 022033-F	RUSTY	U-CHANNEL	0.858	1.272	1.339	21.8	32.3	34.0	100
TIPS 027034-U	BLUE	FLAT	0.941	1.335	0.980	23.9	33.9	24.9	100
TIPS 029037-F	RUSTY	U-CHANNEL	1.157	1.449	1.449	29.4	36.8	36.8	100
TIPS 031041-F	RUSTY	FLAT	1.228	1.598	1.063	31.2	40.6	27.0	100
TIPS 033039-F	RUSTY	FLAT	1.299	1.535	1.201	33.0	39.0	30.5	100
TIPS 038048-F	RUSTY	U-CHANNEL	1.496	1.886	1.319	38.0	47.9	33.5	100
TIPS 042052-F	RUSTY	U-CHANNEL	1.645	2.035	2.035	41.8	51.7	51.7	100
TIPS 047056-F	RUSTY	U-CHANNEL	1.850	2.201	1.500	47.0	55.9	38.1	50
TIPS 047057-F	RUSTY	U-CHANNEL	1.854	2.201	1.500	47.1	55.9	38.1	50

■ Current pricing and additional sizes available at [www.epsi.com](http://www.epsi.com)



866-ASK-EPSI (866-275-3774)  
866-FAX-EPSI (866-329-3774)

32

Order online at  
[www.epsi.com](http://www.epsi.com)

**YOU ASK IT.  
WE MASK IT.®**

# TOPS Shallow Tube Plugs

600°F (315°C)



- Masking Chamfered and Machined Bores
- Creates Liquid Tight Seal for E-Coat and Plating Applications
- Off-Set Handle for Easy Removal
- Plugging of Large Diameter Shallow Bores

## PRODUCT DESCRIPTION

The TOPS hollow body compresses against the inside walls of a bore to create a liquid/air tight seal. TOPS are especially effective when a large diameter, yet shallow through hole must be plugged on both sides. Traditional stoppers can "bottom-out" against each other before a correct seal is accomplished.

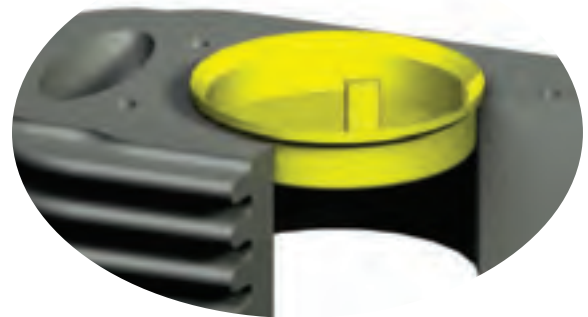

## HELPFUL HINTS

- When plugging a hole, make sure that the major diameter of the plug is at least 10% larger than the diameter of the hole being plugged.
- Mask both ends of shallow machined bores with two plugs.

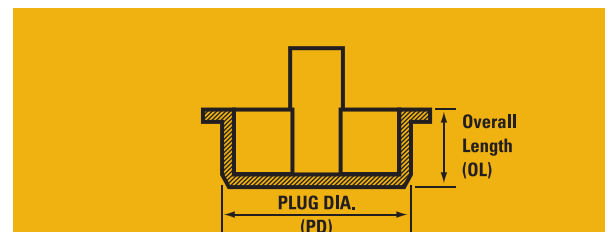

## TOPS SERIES

PART NUMBER	COLOR	STANDARD		METRIC		BOX QTY
		PD (n)	OL (in)	PD (mm)	OL (mm)	
TOPS 036020-L	YELLOW	1.402	0.787	35.6	20.0	100
TOPS 041016-L	YELLOW	1.598	0.618	40.6	15.7	100
TOPS 046006-L	YELLOW	1.791	0.232	45.5	5.9	100
TOPS 047034-L	YELLOW	1.831	1.339	46.5	34.0	50
TOPS 054020-L	YELLOW	2.110	0.791	53.6	20.1	50
TOPS 075015-L	YELLOW	2.933	0.591	74.5	15.0	50
TOPS 090034-L	YELLOW	3.543	1.346	90.0	34.2	25

■ Current pricing and additional sizes available at [www.epsi.com](http://www.epsi.com)



866-ASK-EPSI (866-275-3774)  
866-FAX-EPSI (866-329-3774)

33

Order online at [www.epsi.com](http://www.epsi.com)



# BTM Blind-Hole Thread Mask Plugs

600°F (315°C)



- Shallow Design is Ideal for Blind Hole Applications
- Flange Geometry is Specially Engineered to Mask off Lead-In Chamfers of Threads

- Make Sure Diameter of Mask is at Least 5% Greater than Hole Size.



## PRODUCT DESCRIPTION

Our Blind-Hole Threaded Mask (BTM) product line is the answer to the common problem of masking off blind threaded holes. The BTM product line has several features engineered into their design to ensure complete sealing of threads.

Starter Kit Available.  
See page 109



## BTM SERIES

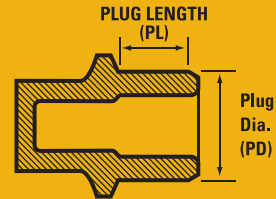

PART NUMBER	COLOR	STANDARD		METRIC		BOX QTY
		THREAD SIZE	THREAD SIZE	PD (in)	PL (in)	
BTM 0208-C	CLEAR		M6	0.208	0.197	500
BTM 0218-L	YELLOW	1/4		0.218	0.200	500
BTM 0278-G	GREEN	5/16		0.278	0.200	500
BTM 0283-U	BLUE		M8	0.283	0.197	500
BTM 0336-W	WHITE	3/8		0.336	0.250	500
BTM 0358-N	PINK		M10	0.358	0.276	250
BTM 0392-O	ORANGE	7/16		0.392	0.350	250
BTM 0426-F	RUSTY		M12	0.426	0.346	250
BTM 0451-C	CLEAR	1/2		0.451	0.350	250
BTM 0583-G	GREEN		M16	0.583	0.433	100
BTM 0724-L	YELLOW		M20	0.724	0.512	100

■ Current pricing and additional sizes available at [www.epsi.com](http://www.epsi.com)



866-ASK-EPSI (866-275-3774)  
866-FAX-EPSI (866-329-3774)

34

Order online at  
[www.epsi.com](http://www.epsi.com)

**YOU ASK IT.  
WE MASK IT.®**



# SPP Silicone Pull Plugs

600°F (315°C)



■ When Pulled Through Holes, Large Diameter Compresses Until Released, Providing for a Tight Seal

■ Chamfered Neck and Smaller Pull-Tab Diameter Aid Insertion



## PRODUCT DESCRIPTION

Our Silicone Pull Plug (SPP) product line is the industry standard solution for threaded and non-threaded through holes in powder coating and E-coating applications. With many sizes available, holes from 0.050" to 2.250" in diameter can easily be plugged.

## HELPFUL HINTS

• When plugging a hole, make sure that the major diameter of the plug is larger than the diameter of the hole being plugged by at least 4%.

- Keep in mind any interference issues that will be created by the Pull-Tab being exposed after plug is inserted.
- Not recommended for holes with a lead-in chamfer or a countersink that require protection from paint. For these applications, EPSI recommends the Weld Nut Pull Plug (WPP) or the Washer Plug (WP) lines.



Starter Kit Available. See page 108

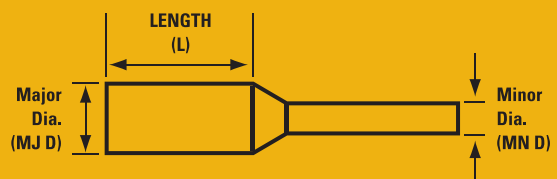

## SPP SERIES

PART NUMBER	COLOR	STANDARD			METRIC			BOX QTY
		MJ D (in)	MN D (in)	L (in)	MJ D (mm)	MN D (mm)	L (mm)	
SPP 0073X0625-G	GREEN	0.073	0.047	0.625	1.9	1.2	15.9	500
SPP 0091X0625-L	YELLOW	0.091	0.062	0.625	2.3	1.6	15.9	500
SPP 0091X1000-L	YELLOW	0.091	0.052	1.000	2.3	1.3	25.4	500
SPP 0093X0625-Y	GRAY	0.093	0.062	0.625	2.4	1.6	158.8	500
SPP 0105X1000-U	BLUE	0.105	0.070	1.000	2.7	1.8	25.4	500
SPP 0109X0625-R	RED	0.109	0.062	0.625	2.8	1.6	15.9	500
SPP 0109X1000-R	RED	0.109	0.062	1.000	2.8	1.6	25.4	500
SPP 0118X1000-C	CLEAR	0.118	0.082	1.000	3.0	2.1	25.4	500



866-ASK-EPSI (866-275-3774)  
866-FAX-EPSI (866-329-3774)

35

Order online at  
[www.epsi.com](http://www.epsi.com)

**YOU ASK IT.  
WE MASK IT.®**



# SPP SERIES

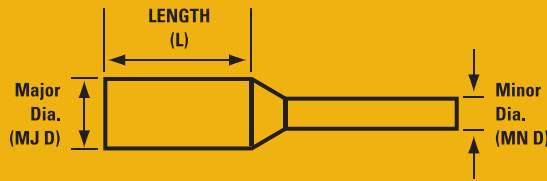

PART NUMBER	COLOR	STANDARD			METRIC			BOX QTY
		MJ D (in)	MN D (in)	L (in)	MJ D (mm)	MN D (mm)	L (mm)	
SPP 0125X0625-W	WHITE	0.125	0.082	0.625	3.2	2.1	15.9	500
SPP 0130X0625-N	PINK	0.130	0.082	0.625	3.3	2.1	15.9	500
SPP 0130X1000-C	CLEAR	0.130	0.082	1.000	3.3	2.1	25.4	500
SPP 0140X0625-G	GREEN	0.140	0.082	0.625	3.6	2.1	15.9	500
SPP 0145X1250-B	BLACK	0.145	0.093	1.250	3.7	2.4	31.8	500
SPP 0154X0625-L	YELLOW	0.154	0.082	0.625	3.9	2.1	15.9	500
SPP 0156X0625-Y	GRAY	0.156	0.082	0.625	4.0	2.1	15.9	500
SPP 0156X1250-Y	GRAY	0.156	0.093	1.250	4.0	2.4	31.8	500
SPP 0158X1000-O	ORANGE	0.158	0.093	1.000	4.0	2.4	25.4	500
SPP 0158X1500-O	ORANGE	0.158	0.093	1.500	4.0	2.4	38.1	500
SPP 0160X0780-C	CLEAR	0.160	0.118	0.780	4.1	3.0	19.8	500
SPP 0162X0625-U	BLUE	0.162	0.093	0.625	4.1	2.4	15.9	500
SPP 0175X1250-P	PURPLE	0.175	0.123	1.250	4.4	3.1	31.8	500
SPP 0187X0625-R	RED	0.187	0.110	0.625	4.7	2.8	15.9	500
SPP 0190X1250-L	YELLOW	0.190	0.140	1.250	4.8	3.6	31.8	500
SPP 0195X0625-W	WHITE	0.195	0.110	0.625	5.0	2.8	15.9	500
SPP 0195X1250-W	WHITE	0.195	0.110	1.250	5.0	2.8	31.8	500
SPP 0197X1000-F	RUSTY	0.197	0.110	1.000	5.0	2.8	25.4	500
SPP 0218X1000-C	CLEAR	0.218	0.110	1.000	5.5	2.8	25.4	500
SPP 0225X1000-N	PINK	0.225	0.125	1.000	5.7	3.2	25.4	500
SPP 0225X1181-N	PINK	0.225	0.120	1.181	5.7	3.0	30.0	500
SPP 0236X0400-O	ORANGE	0.236	0.177	0.400	6.0	4.5	10.2	500
SPP 0236X1250-O	ORANGE	0.236	0.165	1.250	6.0	4.2	31.8	500
SPP 0244X1250-P	PURPLE	0.244	0.170	1.250	6.2	4.3	31.8	500
SPP 0257X1000-G	GREEN	0.257	0.130	1.000	6.5	3.3	25.4	500
SPP 0260X1000-U	BLUE	0.260	0.130	1.000	6.6	3.3	25.4	500
SPP 0265X1250-Y	GRAY	0.265	0.186	1.250	6.7	4.7	31.8	500
SPP 0275X0950-L	YELLOW	0.275	0.130	0.950	7.0	3.3	24.1	500
SPP 0281X1000-R	RED	0.281	0.138	1.000	7.1	3.5	25.4	500
SPP 0312X1000-Y	GRAY	0.312	0.147	1.000	7.9	3.7	25.4	500
SPP 0312X1250-Y	GRAY	0.312	0.187	1.250	7.9	4.7	31.8	500
SPP 0332X1125-U	BLUE	0.332	0.250	1.125	8.4	6.4	28.6	500
SPP 0335X1000-W	WHITE	0.335	0.157	1.000	8.5	4.0	25.4	500
SPP 0350X0900-C	CLEAR	0.350	0.157	0.900	8.9	4.0	22.9	500
SPP 0370X0454-C	CLEAR	0.370	0.187	0.454	9.4	4.7	11.5	250
SPP 0375X1000-L	YELLOW	0.375	0.157	1.000	9.5	4.0	25.4	250
SPP 0388X1000-R	RED	0.388	0.157	1.000	9.9	4.0	25.4	250
SPP 0400X1000-C	CLEAR	0.400	0.157	1.000	10.2	4.0	25.4	250



866-ASK-EPSI (866-275-3774)  
866-FAX-EPSI (866-329-3774)

Order online at  
[www.epsi.com](http://www.epsi.com)

**YOU ASK IT.  
WE MASK IT.**

## SPP SERIES

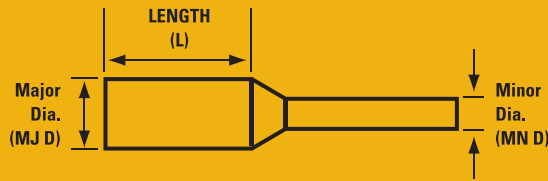

PART NUMBER	COLOR	STANDARD			METRIC			BOX QTY
		MJ D (in)	MN D (in)	L (in)	MJ D (mm)	MN D (mm)	L (mm)	
SPP 0414X1000-G	GREEN	0.414	0.157	1.000	10.5	4.0	25.4	250
SPP 0437X1250-F	RUSTY	0.437	0.306	1.250	11.1	7.8	31.8	250
SPP 0440X1000-L	YELLOW	0.440	0.157	1.000	11.2	4.0	25.4	250
SPP 0440X2000-B	BLACK	0.440	0.157	2.000	11.2	4.0	50.8	250
SPP 0445X1000-Y	GRAY	0.445	0.255	1.000	11.3	6.5	25.4	250
SPP 0468X1250-U	BLUE	0.468	0.250	1.250	11.9	6.4	31.8	250
SPP 0500X1000-W	WHITE	0.500	0.250	1.000	12.7	6.4	25.4	100
SPP 0510X1000-C	CLEAR	0.510	0.250	1.000	13.0	6.4	25.4	100
SPP 0530X1000-N	PINK	0.530	0.250	1.000	13.5	6.4	25.4	100
SPP 0551X1181-C	CLEAR	0.551	0.250	1.181	14.0	6.4	30.0	100
SPP 0580X1500-F	RUSTY	0.580	0.315	1.500	14.7	8.0	38.1	100
SPP 0590X1000-R	RED	0.590	0.250	1.000	15.0	6.4	25.4	100
SPP 0612X1000-L	YELLOW	0.612	0.250	1.000	15.5	6.4	25.4	100
SPP 0640X1000-Y	GRAY	0.640	0.375	1.000	16.3	9.5	25.4	100
SPP 0640X1772-C	CLEAR	0.640	0.375	1.772	16.3	9.5	45.0	100
SPP 0700X1250-U	BLUE	0.700	0.375	1.250	17.8	9.5	31.8	100
SPP 0700X1500-U	BLUE	0.700	0.371	1.500	17.8	9.4	38.1	100
SPP 0729X1000-W	WHITE	0.729	0.315	1.000	18.5	8.0	25.4	100
SPP 0729X1500-W	WHITE	0.729	0.386	1.500	18.5	9.8	38.1	100
SPP 0740X1890-C	CLEAR	0.740	0.364	1.890	18.8	9.2	48.0	100
SPP 0770X1125-C	CLEAR	0.770	0.375	1.125	19.6	9.5	28.6	50
SPP 0770X1500-C	CLEAR	0.770	0.408	1.500	19.6	10.4	38.1	50
SPP 0809X1000-N	PINK	0.809	0.315	1.000	20.5	8.0	25.4	50
SPP 0896X1000-G	GREEN	0.896	0.375	1.000	22.8	9.5	25.4	50
SPP 1020X1250-L	YELLOW	1.020	0.375	1.250	25.9	9.5	31.8	50
SPP 1265X2470-U	BLUE	1.265	0.625	2.470	32.1	15.9	62.7	50
SPP 2000X2000-F	RUSTY	2.000	0.787	2.000	50.8	20.0	50.8	25

## HOLLOW SPP SERIES

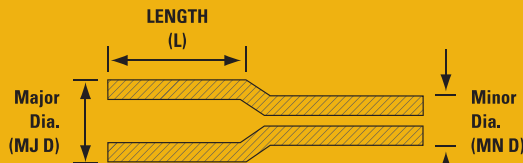

PART NUMBER	COLOR	STANDARD			METRIC			BOX QTY
		MJ D (in)	MN D (in)	L (in)	MJ D (mm)	MN D (mm)	L (mm)	
SPP 1024X1772-L	YELLOW	1.024	0.689	1.772	26.0	17.5	45.0	50
SPP 1713X2756-L	YELLOW	1.713	0.866	2.756	43.5	22.0	70.0	25
SPP 2280X2000-L	YELLOW	2.280	1.140	2.000	57.9	29.0	50.8	10

■ Current pricing and additional sizes available at [www.epsi.com](http://www.epsi.com)



866-ASK-EPSI (866-275-3774)  
866-FAX-EPSI (866-329-3774)

37

Order online at  
[www.epsi.com](http://www.epsi.com)



# WPP Weld-Nut Pull Plugs

600°F (315°C)



■ Dimpled Washer Conforms to Irregular Surfaces and Masks Off Countersinks and Lead-In Threads

■ Pull-Tab Allows for a Larger Diameter Plug to be Pulled into Place for a Tight Seal

■ High Temperature Silicone Formulation Ensures Stability at Elevated Temperatures

■ Designed to Pull Through Same Direction as Applied to Create a Clean Break from any Surface After Coating

## PRODUCT DESCRIPTION

Our Weld-Nut Pull Plug (WPP) product line is a pull plug line specifically engineered to tackle the tough requirements of masking off the lead-in chamfer of threaded applications. Made of our special formulation of high temperature silicone, Weld-Nut Pull Plugs exhibit remarkable flexibility, while maintaining reusability and reliability during masking.

## TYPICAL INDUSTRIES USED

Powder Coating, E-Coating, Plating and Anodizing

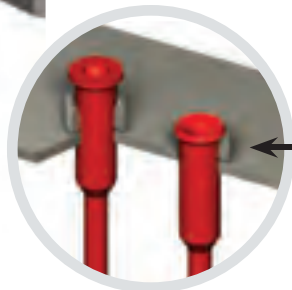

Conforms to Chamfer

## TYPICAL APPLICATIONS

Used to plug weld-nuts during welding. Plug can remain in place for subsequent coating process. Other applications include protecting countersink and leading threads; especially where a tight seal is required.

## HELPFUL HINTS

- When plugging a hole, make sure that the major diameter of the plug is larger than the diameter of the hole being plugged by at least 10%.
- Use Weld-Nut Pull Plugs (WPP) in applications where countersinks or lead-in chamfers are necessary masking areas.
- Keep in mind any interference issues that will be created by the Pull-Tab being completely exposed after plug is inserted.



866-ASK-EPSI (866-275-3774)  
866-FAX-EPSI (866-329-3774)

38

Order online at  
[www.epsi.com](http://www.epsi.com)

**YOU ASK IT.  
WE MASK IT.®**

# WPP SERIES

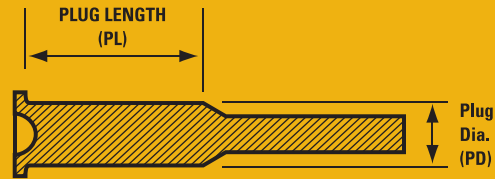

PART NUMBER	COLOR	STANDARD THREAD SIZE		STANDARD PD PL (in)		METRIC PD PL (mm)		BOX QTY
WPP 0173-R	RED	#10	M5	0.173	1.000	4.4	25.4	500
WPP 0217-U	BLUE	1/4	M6	0.217	1.000	5.5	25.4	500
WPP 0224-Y	GRAY			0.224	1.000	5.7	25.4	500
WPP 0283-L	YELLOW	5/16	M8	0.283	1.000	7.2	25.4	500
WPP 0331-O	ORANGE	3/8	M9	0.331	1.000	8.4	25.4	500
WPP 0346-N	PINK		M10	0.346	1.000	8.8	25.4	500
WPP 0413-G	GREEN	7/16	M11	0.413	1.000	10.5	25.4	250
WPP 0439-P	PURPLE		M12	0.439	1.000	11.2	25.4	250
WPP 0490-W	WHITE	1/2	M14	0.490	1.000	12.4	25.4	250
WPP 0518-Y	GRAY	9/16		0.518	1.000	13.2	25.4	250
WPP 0545-F	RUSTY	5/8		0.545	1.000	13.8	25.4	250
WPP 0580-R	RED		M16	0.580	1.000	14.7	25.4	250

■ Current pricing and additional sizes available at [www.epsi.com](http://www.epsi.com)

Starter Kit Available.  
See page 109



866-ASK-EPSI (866-275-3774)  
866-FAX-EPSI (866-329-3774)

39

Order online at  
[www.epsi.com](http://www.epsi.com)

**YOU ASK IT.  
WE MASK IT.®**

# DWP Double Washer Pull Plugs

600°F (315°C)

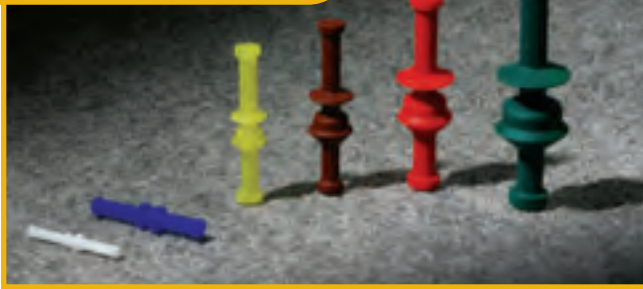

- Masks entry and exit threads simultaneously
- Designed for common metric threads
- Provides positive seal

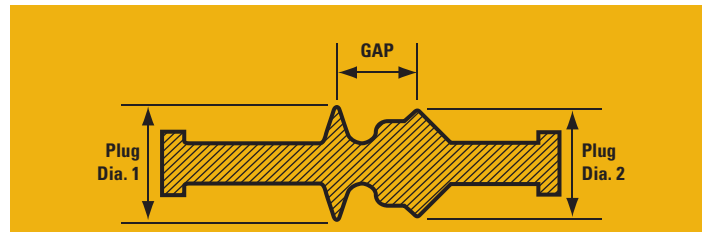

## DWP SERIES

PART NUMBER	METRIC THREAD	PLUG DIAMETER 1 (in)	PLUG DIAMETER 2 (in)	GAP (in)	BAG QTY
DWP M04	M4	0.145	0.174	0.125	1000
DWP M05	M5	0.211	0.207	0.14	1000
DWP M06	M6	0.243	0.243	0.176	1000
DWP M08	M8	0.325	0.323	0.242	1000
DWP M10	M10	0.412	0.410	0.322	500
DWP M12	M12	0.532	0.503	0.301	500
DWP M16	M16	0.661	0.658	0.377	250
DWP M18	M18	0.748	0.748	0.470	100
DWP M20	M20	0.866	0.866	0.486	100
DWP M22	M22	0.945	0.945	0.486	100



866-ASK-EPSI (866-275-3774)  
866-FAX-EPSI (866-329-3774)

40

Order online at  
[www.epsi.com](http://www.epsi.com)

**YOU ASK IT.  
WE MASK IT.®**



# SOMS Sink-O-Mask™ Plugs

600°F (315°C)

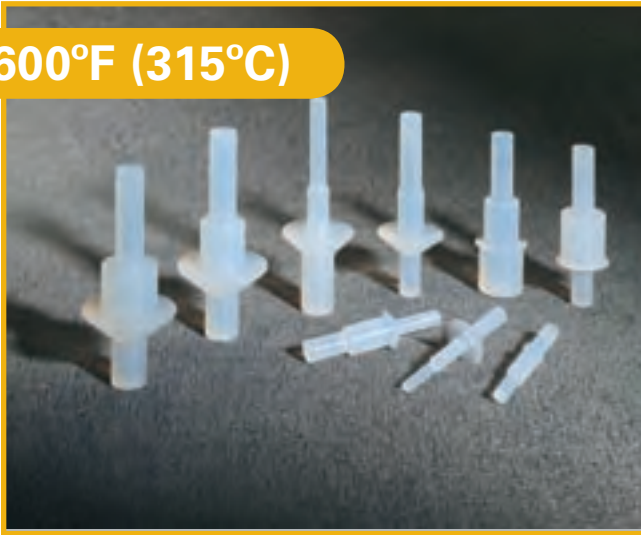

- Masking Through Holes and Surrounding Washer Area
- Sink-O-Mask™ Plugs Feature Pull Tab for Easy Removal After Coating

## PRODUCT DESCRIPTION

The Sink-O-Mask™ (SOM™) should be used where it is necessary to protect both a through hole and its surrounding washer area. The tapered design of the flange resists lifting at the edges for a clean finish.

## HELPFUL HINTS

- When plugging a hole, make sure that the plug diameter is larger than the diameter of the hole being plugged by at least 5%.



Starter Kit Available. See page 108

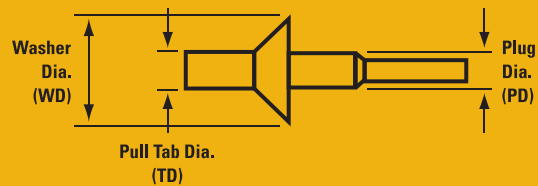

## SOMS™ SERIES

PART NUMBER	STANDARD			METRIC			BOX QTY
	PD (in)	WD (in)	TD (in)	PD (mm)	WD (mm)	TD (mm)	
SOMS X2012-C	0.118	0.197	0.138	3.0	5.0	3.5	500
SOMS X3116-C	0.157	0.311	0.118	4.0	7.9	3.0	500
SOMS X4016-C	0.157	0.394	0.138	4.0	10.0	3.5	500
SOMS X4020-C	0.197	0.394	0.138	5.0	10.0	3.5	500
SOMS X4032-C	0.315	0.394	0.138	8.0	10.0	3.5	500
SOMS X4816-C	0.157	0.472	0.394	4.0	12.0	10.0	500
SOMS X5317-C	0.165	0.530	0.165	4.2	13.5	4.2	500
SOMS X6020-C	0.197	0.591	0.197	5.0	15.0	5.0	250
SOMS X6024-C	0.236	0.591	0.197	6.0	15.0	5.0	250
SOMS X6032-C	0.315	0.591	0.197	8.0	15.0	5.0	250
SOMS X6540-C	0.394	0.649	0.295	10.0	16.5	7.5	250
SOMS X7940-C	0.394	0.787	0.295	10.0	20.0	7.5	100
SOMS X7948-C	0.472	0.787	0.295	12.0	20.0	7.5	100

- Sink-O-Mask™ Plug sizes are conveniently sorted by plug diameter.
- Current pricing and additional sizes available at [www.epsi.com](http://www.epsi.com)



866-ASK-EPSI (866-275-3774)  
866-FAX-EPSI (866-329-3774)

41

Order online at  
[www.epsi.com](http://www.epsi.com)

**YOU ASK IT.  
WE MASK IT.®**

# SMT/EMT Silicone & EPDM Mousetail Plugs

600°F (315°C)/475°F



- Can be Stretched to Provide a Leak-Proof Seal
- Ideal for Plugging Small or Hard to Reach Holes

- Great Resistance to Chemicals and Hydrocarbons (EMT)



## TYPICAL INDUSTRIES USED

Powder Coating, E-Coating, Plating and Anodizing

## TYPICAL APPLICATIONS

Mousetail plugs are typically used as a plug for extremely small holes, especially in electronic components.

## PRODUCT DESCRIPTION

Our Silicone Mousetail (SMT) line is the ideal solution when masking small openings, threaded holes, and small irregularly contoured features. Their thin profiles make them extremely stretchy, allowing them to contract and fit into different size holes. Our high temperature Silicone is specially formulated to ensure reusability and reliability during masking. Our high temperature EPDM Mousetail (EMT) is specially formulated to resist chemical attack and ensure reusability and economy during masking.

## SMT/EMT SERIES

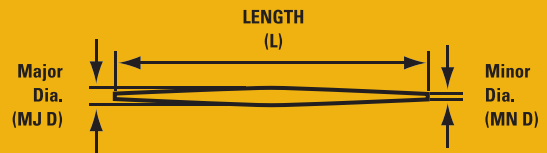

PART NUMBER	STANDARD			METRIC			BOX QTY
	MJ D (in)	MN D (in)	L (in)	MJ D (mm)	MN D (mm)	L (mm)	
SMT 0079 or EMT 0079	0.079	0.022	1.332	2.0	0.6	33.8	1000
SMT 0080 or EMT 0080	0.080	0.023	2.083	2.0	0.6	52.9	1000
SMT 0083 or EMT 0083	0.083	0.031	1.928	2.1	0.8	49.0	1000
SMT 0100 or EMT 0100	0.100	0.030	2.080	2.5	0.8	52.8	1000

■ Current pricing and additional sizes available at [www.epsi.com](http://www.epsi.com)



866-ASK-EPSI (866-275-3774)  
866-FAX-EPSI (866-329-3774)

42

Order online at  
[www.epsi.com](http://www.epsi.com)

**YOU ASK IT.  
WE MASK IT.®**

# TNM Thread-N-Mask Plugs

185°F (85°C)



- Plugging Threaded Holes in Plating and Anodizing Applications
- Self-Tapping for Liquid Tight Seal
- Great Chemical Resistance
- One-Time Use

## PRODUCT DESCRIPTION

The Thread-N-Mask (TNM) plugs are self-tapping. Made from a pliable LDPE plastic, these plugs offer excellent chemical resistance. They are inexpensive enough to be used only one-time.

## HELPFUL HINTS

- Insert the lead-in smaller diameter squarely into the threaded hole. Begin twisting the TNM plug. The TNM will begin to take on the shape of the threads, forming a leak-proof seal.
- It is recommended that at least 1/4 of the plug be threaded into the hole.

Starter Kit Available. See page 109

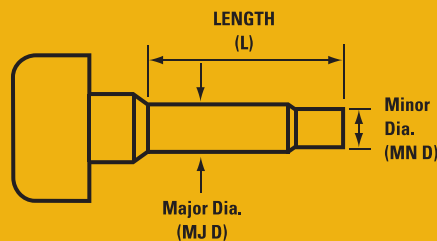

## TNM SERIES

PART NUMBER	THREAD SIZE	STANDARD			METRIC			BOX QTY
		MJ D (in)	MN D (in)	L (in)	MJ D (mm0)	MN D (mm)	L (mm)	
TNM 0082	#2	0.082	0.062	0.660	2.1	1.6	16.8	500
TNM 0100	#3	0.100	0.080	0.600	2.5	2.0	15.2	500
TNM 0106	#4	0.106	0.085	0.668	2.7	2.2	17.0	500
TNM 0120	#5	0.120	0.095	0.735	3.0	2.4	18.7	500
TNM 0131	#6	0.131	0.105	0.803	3.3	2.7	20.4	500
TNM 0156	#8	0.156	0.136	0.780	4.0	3.5	19.8	500
TNM 0171	#10	0.171	0.143	0.800	4.3	3.6	20.3	500
TNM 0186	#12	0.186	0.150	0.820	4.7	3.8	20.8	250
TNM 0212	1/4	0.212	0.180	0.895	5.4	4.6	22.7	250
TNM 0270	5/16	0.270	0.210	1.120	6.9	5.3	28.4	250
TNM 0335	3/8	0.335	0.295	0.890	8.5	7.5	22.6	250
TNM 0400	7/16	0.400	0.348	1.005	10.2	8.8	25.5	250
TNM 0470	1/2	0.470	0.400	1.120	11.9	10.2	28.4	250

■ Current pricing and additional sizes available at [www.epsi.com](http://www.epsi.com)



866-ASK-EPSI (866-275-3774)  
866-FAX-EPSI (866-329-3774)

43

Order online at  
[www.epsi.com](http://www.epsi.com)

**YOU ASK IT.  
WE MASK IT.®**

# EPP EPDM Pull Plugs

475°F (250°C)



■ Chamfered Neck and Smaller Pull-Tab Diameter Aid Insertion

■ When Pulled Through Holes, Large Diameter Compresses Until Released, Providing for a Tight Seal

■ High Temperature EPDM Formulation is Extremely Chemically Resistant and Economical

## TYPICAL INDUSTRIES USED

Powder Coating, E-Coating, Plating, Anodizing, Wet Spray and Shot Blasting

## TYPICAL APPLICATIONS

Used as a plug for non-threaded and threaded through holes.



## PRODUCT DESCRIPTION

Our EPDM Pull Plug (EPP) product line is an extremely economical solution for threaded and non-threaded through hole applications. With many sizes available, holes from 0.050" to 2.250" in diameter can easily be plugged. Our high temperature EPDM is specially formulated to ensure chemical resistance while maintaining reusability and economy during masking.

## HELPFUL HINTS

- When plugging a hole, make sure that the major diameter of the plug is larger than the diameter of the hole being plugged by at least 4%.
- Keep in mind any interference issues that will be created by the Pull-Tab being exposed after plug is inserted.
- Not recommended for holes with a lead-in chamfer or a countersink that requires protection from paint. For these applications, EPSI recommends the Weld Nut Pull Plug (WPP) or the Washer Plug (WP) lines.



866-ASK-EPSI (866-275-3774)  
866-FAX-EPSI (866-329-3774)

44

Order online at  
[www.epsi.com](http://www.epsi.com)

**YOU ASK IT.  
WE MASK IT.®**

# EPP SERIES

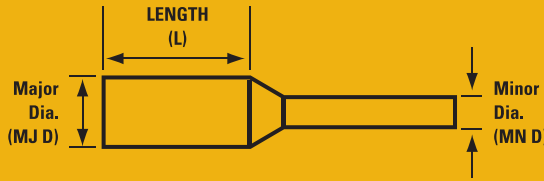

PART NUMBER	STANDARD			METRIC			BOX QTY
	MJ D (in)	MN D (in)	L (in)	MJ D (mm)	MN D (mm)	L (mm)	
EPP 0093X0625	0.093	0.062	0.625	2.4	1.6	15.9	500
EPP 0109X0625	0.109	0.062	0.625	2.8	1.6	15.9	500
EPP 0118X1000	0.118	0.082	1.000	3.0	2.1	25.4	500
EPP 0130X0625	0.130	0.082	0.625	3.3	2.1	15.9	500
EPP 0140X0625	0.140	0.082	0.625	3.6	2.1	15.9	500
EPP 0154X0625	0.154	0.082	0.625	3.9	2.1	15.9	500
EPP 0156X0625	0.156	0.082	0.625	4.0	2.1	15.9	500
EPP 0162X0625	0.162	0.093	0.625	4.1	2.4	15.9	500
EPP 0187X0625	0.187	0.110	0.625	4.7	2.8	15.9	500
EPP 0195X0625	0.195	0.110	0.625	5.0	2.8	15.9	500
EPP 0197X1000	0.197	0.110	1.000	5.0	2.8	25.4	500
EPP 0225X1000	0.225	0.125	1.000	5.7	3.2	25.4	500
EPP 0281X1000	0.281	0.138	1.000	7.1	3.5	25.4	500
EPP 0312X1000	0.312	0.147	1.000	7.9	3.7	25.4	500
EPP 0332X1125	0.332	0.250	1.125	8.4	6.4	28.6	500
EPP 0335X1000	0.335	0.157	1.000	8.5	4.0	25.4	500
EPP 0350X0900	0.350	0.157	0.900	8.9	4.0	22.9	500
EPP 0388X1000	0.388	0.157	1.000	9.9	4.0	25.4	250
EPP 0400X1000	0.400	0.157	1.000	11.2	4.0	25.4	250
EPP 0445X1000	0.445	0.255	1.000	11.3	6.5	25.4	250
EPP 0468X1250	0.468	0.250	1.250	11.9	6.4	31.8	250
EPP 0500X1000	0.500	0.250	1.000	12.7	6.4	25.4	100
EPP 0770X1125	0.770	0.375	1.125	19.6	9.5	28.6	50
EPP 1020X1250	1.020	0.375	1.250	25.9	9.5	31.8	50

■ Current pricing and additional sizes available at [www.epsi.com](http://www.epsi.com)

Starter Kit Available. See page 109



866-ASK-EPSI (866-275-3774)  
866-FAX-EPSI (866-329-3774)

Order online at [www.epsi.com](http://www.epsi.com)

**YOU ASK IT.  
WE MASK IT.**



# TPP Triple Push Plug

600°F (315°C)



## PRODUCT DESCRIPTION

One TPP will mask three threaded holes, provide better chamfered lead coverage and be easier to apply uniformly than the FLPS. Furthermore, since one TPP masks three threaded holes, this will translate into cost savings for you, as you only have to purchase one plug as opposed to three. Alternative to FLPS and BTM.

To apply TPP's, simply push and twist in threaded hole.

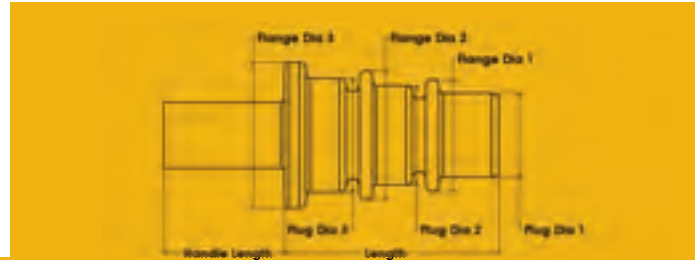

## TRIPLE PUSH PLUG

### PART NUMBER

### DESCRIPTION

TPP 0375 X 0500

Plugs 3/8-16; 7/16-14; 1/2-13 Threaded Holes

TPP 0563 X 0750

Plugs 3/4-10; 5/8-11; 9/16-12 Threaded Holes



866-ASK-EPSI (866-275-3774)  
866-FAX-EPSI (866-329-3774)

46

Order online at  
[www.epsi.com](http://www.epsi.com)

**YOU ASK IT.  
WE MASK IT.®**

# R12 Rusty Poly Tape

430°F (220°C)



■ Maximum Temperature: 430°F

■ Removes Cleanly After Use with No Shrinkage

## PRODUCT DESCRIPTION

Our R12 rusty polyester tape is ideal for high temp powder coating and e-coating applications. It is an economical choice for applications requiring temperature resistance greater than general purpose green polyester tape, but less than the high temp polyimide tapes.

## SHELF LIFE

Shelf life is 6 months from date of shipment when stored in a cool dry place below 76°F (24°C).

## CONSTRUCTION

Total Thickness	3.4 mils
Adhesive Thickness	1.4 mils
Carrier Thickness	2.0 mils
Adhesive Type	Silicone
Carrier Type	Polyester

## SPECIFICATIONS

Maximum Temperature (F)	430
Tensile Strength (lbs/inch)	50
Elongation (%)	100
Peel Adhesion (oz/inch)	35

PART NUMBER	WIDTH (in)	STANDARD		METRIC		CASE QTY
		WIDTH (in)	LENGTH (yds)	WIDTH (mm)	LENGTH (m)	
R12-00064	0.250	1/4	72	6.4	66	96
R12-00095	0.375	3/8	72	9.5	66	64
R12-00127	0.500	1/2	72	12.7	66	48
R12-00159	0.625	5/8	72	15.9	66	40
R12-00190	0.750	3/4	72	19.0	66	32
R12-00254	1.000	1	72	25.4	66	24
R12-00318	1.250	1 1/4	72	31.8	66	20
R12-00381	1.500	1 1/2	72	38.1	66	16
R12-00508	2.000	2	72	50.8	66	12
R12-00762	3.000	3	72	76.2	66	8
R12-01016	4.000	4	72	101.6	66	8
R12-01270	5.000	5	72	127.0	66	4
R12-01524	6.000	6	72	152.4	66	4

■ Other sizes available upon request.

■ Current pricing available at [www.epsi.com](http://www.epsi.com)

430°F intermittent rating. Contact an EPSI representative for recommendations on tapes for continuous or extended use. Many factors can affect the use and performance of a product in a particular application. This product should be tested to determine the suitability for its intended use.



866-ASK-EPSI (866-275-3774)  
866-FAX-EPSI (866-329-3774)

47

Order online at  
[www.epsi.com](http://www.epsi.com)

**YOU ASK IT.  
WE MASK IT.®**

# A12 Green Poly Tape

400°F (204°C)



- Maximum Temperature: 400°F
- Total Thickness: 3.5 mils
- Hi-Temperature Silicone Adhesive System
- Removes Cleanly After Use
- No Shrinkage

## PRODUCT DESCRIPTION

A12 is a polyester film, single coated with a silicone pressure sensitive adhesive.

## TYPICAL APPLICATION

Masking in Powder Coating, E-Coating, Anodizing and Some Plating Applications.

## CONSTRUCTION

Total Thickness	3.5 mils
Adhesive Thickness	1.5 mils
Carrier Thickness	2.0 mils
Adhesive Type	Silicone
Carrier Type	Polyester
Color	Green

## SPECIFICATIONS

Maximum Temperature (F)	400
Tensile Strength (lbs/inch)	50
Elongation (%)	110
Peel Adhesion (oz/inch)	35

Our A12 green polyester tape is the industry standard for general purpose powder coating applications. It is extremely economical and removes cleanly from surfaces without leaving a residue. A12 is ideal for applications such as taping off large surfaces, general purpose die cutting, and large volume runs.

## SHELF LIFE

Shelf life is 6 months from date of shipment when stored in a cool dry place below 76°F (24°C). Rolls should be stored on end.

400°F intermittent rating. Contact an EPSI representative for recommendations on tapes for continuous or extended use. Many factors can affect the use and performance of a product in a particular application. This product should be tested to determine the suitability for its intended use.



866-ASK-EPSI (866-275-3774)  
866-FAX-EPSI (866-329-3774)

48

Order online at  
[www.epsi.com](http://www.epsi.com)

**YOU ASK IT.  
WE MASK IT.®**

# A12 SERIES

PART NUMBER	WIDTH (in)	STANDARD		METRIC		CASE QTY
		WIDTH (in)	LENGTH (yds)	WIDTH (mm)	LENGTH (m)	
A12-00032	0.125	1/8	72	3.2	66	192
A12-00048	0.188	3/16	72	4.8	66	128
A12-00064	0.250	1/4	72	6.4	66	96
A12-00079	0.313	5/16	72	7.9	66	76
A12-00095	0.375	3/8	72	9.5	66	64
A12-00111	0.438	7/16	72	11.1	66	56
A12-00127	0.500	1/2	72	12.7	66	48
A12-00143	0.563	9/16	72	14.3	66	44
A12-00159	0.625	5/8	72	15.9	66	40
A12-00190	0.750	3/4	72	19.0	66	32
A12-00222	0.875	7/8	72	22.2	66	28
A12-00254	1.000	1	72	25.4	66	24
A12-00286	1.125	1 1/8	72	28.6	66	20
A12-00318	1.250	1 1/4	72	31.8	66	20
A12-00349	1.375	1 3/8	72	34.9	66	16
A12-00381	1.500	1 1/2	72	38.1	66	16
A12-00413	1.625	1 5/8	72	41.3	66	16
A12-00445	1.750	1 3/4	72	44.5	66	12
A12-00508	2.000	2	72	50.8	66	12
A12-00572	2.250	2 1/4	72	57.2	66	12
A12-00635	2.500	2 1/2	72	63.5	66	8
A12-00699	2.750	2 3/4	72	69.9	66	8
A12-00762	3.000	3	72	76.2	66	8
A12-00889	3.500	3 1/2	72	88.9	66	8
A12-01016	4.000	4	72	101.6	66	8
A12-01270	5.000	5	72	127.0	66	4
A12-01524	6.000	6	72	152.4	66	4
A12-01778	7.000	7	72	177.8	66	4
A12-02032	8.000	8	72	203.2	66	4
A12-02540	10.000	10	72	254.0	66	4
A12-03048	12.000	12	72	304.8	66	4

■ Other sizes available upon request.

■ Current pricing available at [www.epsi.com](http://www.epsi.com)



866-ASK-EPSI (866-275-3774)  
866-FAX-EPSI (866-329-3774)

49

Order online at  
[www.epsi.com](http://www.epsi.com)



# O12 Ultra Orange Poly Tape

430°F (220°C)



- Maximum Temperature: 430°F
- Total Thickness: 3.5 mils
- Hi-Temperature Silicone Adhesive System
- Removes Cleanly After Use
- No Shrinkage
- More Flexible Than Green Poly

## PRODUCT DESCRIPTION

O12 is a polyester film, single coated with a silicone pressure sensitive adhesive.

## TYPICAL APPLICATION

Masking in Powder Coating, E-Coating, Anodizing and Some Plating Applications.

## CONSTRUCTION

Total Thickness	3.5 mils
Adhesive Thickness	1.5 mils
Carrier Thickness	2.0 mils
Adhesive Type	Silicone
Carrier Type	Polyester
Color	Orange

## SPECIFICATIONS

Maximum Temperature (F)	430
Tensile Strength (lbs/inch)	50
Elongation (%)	110
Peel Adhesion (oz/inch)	35

Our O12 Ultra Orange polyester tape is the industry standard for general purpose powder coating applications. It is extremely economical and removes cleanly from surfaces without leaving a residue. O12 is ideal for applications such as taping off large surfaces, general purpose die cutting, large volume runs, and multi-bake applications.

## SHELF LIFE

Shelf life is 6 months from date of shipment when stored in a cool dry place below 76°F (24°C). Rolls should be stored on end.

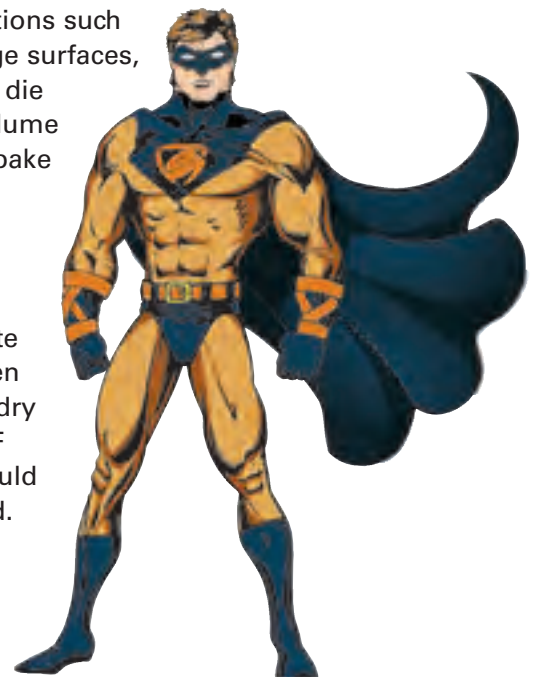

430°F intermittent rating. Contact an EPSI representative for recommendations on tapes for continuous or extended use. Many factors can affect the use and performance of a product in a particular application. This product should be tested to determine the suitability for its intended use.



866-ASK-EPSI (866-275-3774)  
866-FAX-EPSI (866-329-3774)

50

Order online at  
[www.epsi.com](http://www.epsi.com)

**YOU ASK IT.  
WE MASK IT.®**



# O12 SERIES

PART NUMBER	WIDTH (in)	STANDARD WIDTH (in)	LENGTH (yds)	METRIC WIDTH (mm)	METRIC LENGTH (m)	CASE QTY
O12-00032	0.125	1/8	72	3.2	66	192
O12-00048	0.188	3/16	72	4.8	66	128
O12-00064	0.250	1/4	72	6.4	66	96
O12-00079	0.313	5/16	72	7.9	66	76
O12-00095	0.375	3/8	72	9.5	66	64
O12-00111	0.438	7/16	72	11.1	66	56
O12-00127	0.500	1/2	72	12.7	66	48
O12-00143	0.563	9/16	72	14.3	66	44
O12-00159	0.625	5/8	72	15.9	66	40
O12-00190	0.750	3/4	72	19.0	66	32
O12-00222	0.875	7/8	72	22.2	66	28
O12-00254	1.000	1	72	25.4	66	24
O12-00286	1.125	1 1/8	72	28.6	66	20
O12-00318	1.250	1 1/4	72	31.8	66	20
O12-00349	1.375	1 3/8	72	34.9	66	16
O12-00381	1.500	1 1/2	72	38.1	66	16
O12-00413	1.625	1 5/8	72	41.3	66	16
O12-00445	1.750	1 3/4	72	44.5	66	12
O12-00508	2.000	2	72	50.8	66	12
O12-00572	2.250	2 1/4	72	57.2	66	12
O12-00635	2.500	2 1/2	72	63.5	66	8
O12-00699	2.750	2 3/4	72	69.9	66	8
O12-00762	3.000	3	72	76.2	66	8
O12-00889	3.500	3 1/2	72	88.9	66	8
O12-01016	4.000	4	72	101.6	66	8
O12-01270	5.000	5	72	127.0	66	4
O12-01524	6.000	6	72	152.4	66	4
O12-01778	7.000	7	72	177.8	66	4
O12-02032	8.000	8	72	203.2	66	4
O12-02540	10.000	10	72	254.0	66	4
O12-03048	12.000	12	72	304.8	66	4

■ Other sizes available upon request.

■ Current pricing available at [www.epsi.com](http://www.epsi.com)



866-ASK-EPSI (866-275-3774)  
866-FAX-EPSI (866-329-3774)

Order online at  
[www.epsi.com](http://www.epsi.com)



# AW12 Green Wishbone Discs

400°F (204°C)



US Patent  
#6,656,558  
Canada  
#2,279,007  
France  
#0 960 175  
United Kingdom  
#0 960 175  
Germany  
#698 14 358.2-08  
Netherlands  
#0 960 175  
Italy  
#0 960 175  
Sweden  
#0 960 175

- Maximum Temperature: 400°F
- Total Thickness (mils): 3.5 mils (w/o liner)
- Patented Pull Up Tab for Easy Placement and Removal
- Removal Tab in Center Eliminates Shadow Effect Found in Other Designs
- Easy-To-Find Tab; Even under Thickest Coatings
- Hi-Temperature Silicone Adhesive System
- Removes Cleanly After Use
- No Shrinkage

## PRODUCT DESCRIPTION

AW12 is a polyester film, single coated with a silicone pressure sensitive adhesive. Tape is laminated with a center tab, and discs are rotary die-cut on a specially formulated fluorosilicone liner.

## TYPICAL APPLICATION

Masking in Powder Coating, and Wet Spray. Also can be used for E-Coating, Anodizing and Plating applications (See Note Below).

## CONSTRUCTION

Total Thickness	3.5 mils (w/o liner)
Adhesive Thickness	1.5 mils
Carrier Thickness	2.0 mils
Adhesive Type	Silicone
Carrier Type	Polyester
Color	Green

## SPECIFICATIONS

Maximum Temperature (F)	400
Tensile Strength (lbs/inch)	50
Elongation (%)	110
Peel Adhesion (oz/inch)	35

Our U.S. and Internationally Patented AW12 green polyester discs are rapidly becoming the discs of choice for general purpose powder coating applications. Easy grip tab aids in proper disc placement. Eliminate the "hunt" for buried discs that cause rework; the easy-to-find tab makes locating and removing the disc quick and free from surface marring. AW12 discs are cut with high-precision rotary tooling.

## SHELF LIFE

Shelf life is 6 months from date of shipment when stored in a cool dry place below 76°F (24°C). Rolls should be stored on end in original packaging.

400°F intermittent rating. Contact an EPSI representative for recommendations on tapes for continuous or extended use. Many factors can affect the use and performance of a product in a particular application. This product should be tested to determine the suitability for its intended use.



866-ASK-EPSI (866-275-3774)  
866-FAX-EPSI (866-329-3774)

52

Order online at  
[www.epsi.com](http://www.epsi.com)

**YOU ASK IT.  
WE MASK IT.®**

# AW12 SERIES

PART NUMBER	STANDARD DIAMETER (in)	DIAMETER (in)	METRIC DIAMETER (mm)	DISCS PER ROLL
AW12-0100	0.394	—	10.0	500
AW12-0111	0.438	7/16	11.1	500
AW12-0127	0.500	1/2	12.7	500
AW12-0143	0.563	9/16	14.3	500
AW12-0151	0.594	19/32	15.1	500
AW12-0159	0.625	5/8	15.9	500
AW12-0160	0.630	—	16.0	500
AW12-0174	0.685	11/16	17.4	500
AW12-0190	0.750	3/4	19.0	500
AW12-0200	0.787	—	20.0	500
AW12-0206	0.812	13/16	20.6	500
AW12-0214	0.843	27/32	21.4	500
AW12-0222	0.875	7/8	22.2	500
AW12-0254	1.000	1	25.4	500
AW12-0270	1.063	1 1/16	27.0	500
AW12-0286	1.125	1 1/8	28.6	500
AW12-0318	1.250	1 1/4	31.8	500
AW12-0349	1.375	1 3/8	34.9	500
AW12-0381	1.500	1 1/2	38.1	500
AW12-0413	1.625	1 5/8	41.3	250
AW12-0445	1.750	1 3/4	44.5	250
AW12-0476	1.875	1 7/8	47.6	250
AW12-0508	2.000	2	50.8	250
AW12-0572	2.250	2 1/4	57.2	100
AW12-0603	2.375	2 3/8	60.3	100
AW12-0635	2.500	2 1/2	63.5	100
AW12-0699	2.750	2 3/4	69.9	100
AW12-0762	3.000	3	76.2	100
AW12-1016	4.000	4	101.6	100

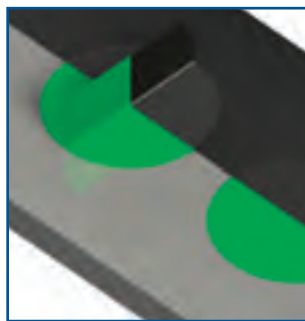

- Other sizes available upon request.
- Current pricing available at [www.epsi.com](http://www.epsi.com)



866-ASK-EPSI (866-275-3774)  
866-FAX-EPSI (866-329-3774)

Order online at [www.epsi.com](http://www.epsi.com)



# AD12 Green Poly Discs

400°F (204°C)

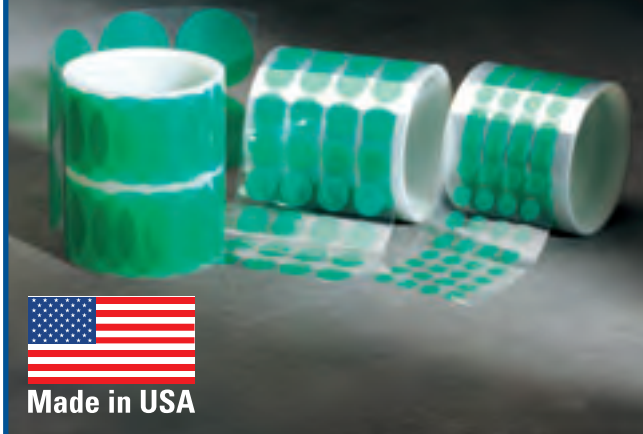

Made in USA

- Maximum Temperature: 400°F
- Removes Cleanly After Use with No Shrinkage

## PRODUCT DESCRIPTION

AD12 is a polyester film, single coated with a silicone pressure sensitive adhesive. Tape is laminated and discs are rotary die-cut on a specially formulated fluorosilicone liner.

## TYPICAL APPLICATION

Powder Coating, E-Coating and Anodizing.

## SHELF LIFE

Shelf life is 6 months from date of shipment when stored in a cool dry place below 76F (24C).

## CONSTRUCTION

Total Thickness	3.5 mils (w/o liner)
Adhesive Thickness	1.5 mils
Carrier Thickness	2.0 mils
Adhesive Type	Silicone
Carrier Type	Polyester
Color	Green

## SPECIFICATIONS

Maximum Temperature (F)	400
Tensile Strength (lbs/inch)	50
Elongation (%)	110
Peel Adhesion (oz/inch)	35

## AD12 SERIES

PART NUMBER	STANDARD DIAMETER (in)	DIAMETER (in)	METRIC DIAMETER (mm)	DISCS PER ROLL
AD12-0032	0.125	1/8	3.2	2000
AD12-0048	0.188	3/16	4.8	2000
AD12-0064	0.250	1/4	6.4	2000
AD12-0079	0.313	5/16	7.9	2000
AD12-0095	0.375	3/8	9.5	2000
AD12-0100	0.394	—	10.0	2000
AD12-0111	0.438	7/16	11.1	2000
AD12-0127	0.500	1/2	12.7	2000
AD12-0127 MEGA	0.500	1/2	12.7	10000
AD12-0143	0.563	9/16	14.3	2000
AD12-0159	0.625	5/8	15.9	2000
AD12-0174	0.685	11/16	17.4	1000
AD12-0190	0.750	3/4	19.0	1000
AD12-0190 MEGA	0.750	3/4	19.0	5000
AD12-0222	0.875	7/8	22.2	1000
AD12-0237	0.937	15/16	23.7	500
AD12-0250	0.984	—	25.0	500
AD12-0254	1.000	1	25.4	500
AD12-0254 MEGA	1.000	1	25.4	2500

400°F intermittent rating. Contact an EPSI representative for recommendations on tapes for continuous or extended use. Many factors can affect the use and performance of a product in a particular application. This product should be tested to determine the suitability for its intended use.



866-ASK-EPSI (866-275-3774)  
866-FAX-EPSI (866-329-3774)

54

Order online at  
[www.epsi.com](http://www.epsi.com)

**YOU ASK IT.  
WE MASK IT.**

## AD12 SERIES (Continued)

PART NUMBER	STANDARD DIAMETER (in)	DIAMETER (in)	METRIC DIAMETER (mm)	DISCS PER ROLL
AD12-0286	1.125	1 1/8	28.6	500
AD12-0302	1.187	1 3/16	30.2	500
AD12-0318	1.250	1 1/4	31.8	500
AD12-0349	1.375	1 3/8	34.9	500
AD12-0365	1.438	1 7/16	36.5	500
AD12-0381	1.500	1 1/2	38.1	500
AD12-0413	1.625	1 5/8	41.3	500
AD12-0445	1.750	1 3/4	44.5	500
AD12-0460	1.183	-	46.0	500
AD12-0476	1.875	1 7/8	47.6	500
AD12-0508	2.000	2	50.8	250
AD12-0572	2.250	2 1/4	57.2	250
AD12-0572 MEGA	2.250	2 1/4	57.2	1250
AD12-0635	2.500	2 1/2	63.5	250
AD12-0635 MEGA	2.500	2 1/2	63.5	1250
AD12-0667	2.625	2 5/8	66.7	250
AD12-0699	2.750	2 3/4	69.9	250
AD12-0762	3.000	3	76.2	250
AD12-0825	3.250	3 1/4	82.5	100
AD12-0889	3.500	3 1/2	88.9	100
AD12-0952	3.750	3 3/4	95.2	100
AD12-1016	4.000	4	101.6	100
AD12-1079	4.250	4 1/4	107.9	100
AD12-1143	4.500	4 1/2	114.3	100
AD12-1270	5.000	5	127.0	100
AD12-1397	5.500	5 1/2	139.7	100
AD12-1524	6.000	6	152.4	100
AD12-1588	6.250	6 1/4	158.8	100

## AD12 SERIES [With Slit Back Liner]

PART NUMBER	STANDARD DIAMETER (in)	DIAMETER (in)	METRIC DIAMETER (mm)	DISCS PER ROLL
AD12-0127-S	0.500	1/2	12.7	2000
AD12-0159-S	0.625	5/8	15.9	2000
AD12-0190-S	0.750	3/4	19.0	1000
AD12-0254-S	1.000	1	25.4	500
AD12-0286-S	1.125	1 1/8	28.6	500
AD12-0318-S	1.250	1 1/4	31.8	500
AD12-0381-S	1.500	1 1/2	38.1	500
AD12-0445-S	1.750	1 3/4	44.5	500
AD12-0508-S	2.000	2	50.8	250
AD12-0572-S	2.250	2 1/4	57.2	250
AD12-0635-S	2.500	2 1/2	63.5	250
AD12-0762-S	3.000	3	76.2	250

■ Other sizes available upon request.

■ Current pricing available at [www.epsi.com](http://www.epsi.com)

■ Custom sizes and shapes can be produced in as little as 2 days



866-ASK-EPSI (866-275-3774)  
866-FAX-EPSI (866-329-3774)

55

Order online at  
[www.epsi.com](http://www.epsi.com)

**YOU ASK IT.  
WE MASK IT.®**



# AH12

# Green Poly Donuts

400°F (204°C)

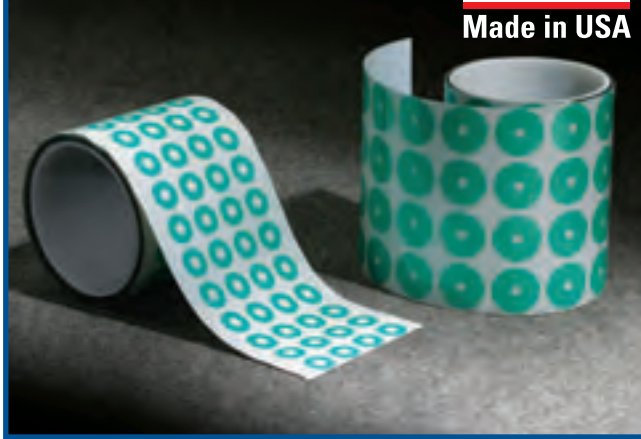

- Maximum Temperature: 400°F
- Removes Cleanly After Use with No Shrinkage

## PRODUCT DESCRIPTION

AD12 is a polyester film, single coated with a silicone pressure sensitive adhesive. Tape is laminated and discs are rotary die-cut on a specially formulated fluorosilicone liner.

## TYPICAL APPLICATION

Powder Coating, E-Coating and Anodizing.

## SHELF LIFE

Shelf life is 6 months from date of shipment when stored in a cool dry place below 76F (24C).

## CONSTRUCTION

Total Thickness	3.5 mils (w/o liner)
Adhesive Thickness	1.5 mils
Carrier Thickness	2.0 mils
Adhesive Type	Silicone
Carrier Type	Polyester
Color	Green

## SPECIFICATIONS

Maximum Temperature (F)	400
Tensile Strength (lbs/inch)	50
Elongation (%)	110
Peel Adhesion (oz/inch)	35

## AH12 SERIES

PART NUMBER	STANDARD		METRIC		DISCS PER ROLL
	OUTER DIAMETER (in)	INNER DIAMETER (in)	OUTER DIAMETER (mm)	INNER DIAMETER (mm)	
AH12-0095X0048	0.375	0.189	9.5	4.8	2000
AH12-0127X0064	0.500	0.250	12.7	6.4	2000
AH12-0159X0064	0.625	0.250	15.9	6.4	2000
AH12-0159X0095	0.625	0.375	15.9	9.5	2000
AH12-0190X0064	0.750	0.250	19.0	6.4	1000
AH12-0254X0048	1.000	0.189	25.4	4.8	500
AH12-0254X0064	1.000	0.250	25.4	6.4	500
AH12-0381X0095	1.500	0.375	25.4	9.5	500
AH12-0381X0254	1.500	1.000	25.4	25.4	500

400°F intermittent rating. Contact an EPSI representative for recommendations on tapes for continuous or extended use. Many factors can affect the use and performance of a product in a particular application. This product should be tested to determine the suitability for its intended use.



866-ASK-EPSI (866-275-3774)  
866-FAX-EPSI (866-329-3774)

56

Order online at  
[www.epsi.com](http://www.epsi.com)

**YOU ASK IT.  
WE MASK IT.®**

# M1000 Automatic Tape Dispenser



- Ideal for Medium Production Facilities
- Automatic Cutter and Tape Feed
- Digital Length Adjustment
- Accepts Tape Widths from 0.28" to 2" (7mm to 50.8mm)
- Cuts Tape Lengths from 0.79" to 39" (20mm to 999mm)
- Adjustable Pressure Feed to Help Prevent Curling of Tape
- Manual Override of Preset Lengths
- Photo-Electronic Actuation of Cutter or Manual Feed
- Cabinet is Made from Flame Retardant Material (Auto Ignition of 896°F)
- 3" Core Holder
- 0.04" Accuracy of Cut (Dependent on Material)
- Weighs 7.3 lbs. (3.4 kg)
- Dimensions: 9.7"L x 5.4"W x 5.9" H
- Electronic Requirements: 117V 50/60Hz, < 1 amp

## M1000 SERIES

PART NUMBER	DESCRIPTION
M1000	2" Wide Electronic Tape Dispenser
M1000-138	Replacement Rubber Rollers (Set of 20)
M1000-254/255	Replacement Blades for Upper and Lower Blades (Set of 2)

# CALIPER



Part No.: Digital Caliper

## TECHNICAL SPECIFICATIONS

Mesuring Range:	0-75mm/0-3", 0-100mm/0-4" 0-150mm/0-6", 0-200mm/0-8" 0-300mm/0-12"
Resolution:	0.01mm/0.0005
Accuracy:	±0.02mm/0.001"(<100mm) ±0.03mm/0.001"(>100-200mm) ±0.04mm/0.0015"(>200-300mm)
Repeatability:	0.01 mm/0.0005"
Max. measuring speed:	1.5m/sec. 60"/sec.
Measuring System:	Linear capacitive measuring system
Display:	LCD display
Power:	One 1.55V button cell

## NOMENCLATURE

1. Internal Measuring Jaws
2. METRIC/INCH change over
3. Locking screw
4. LCD display
5. External Measuring Jaws
6. Power off button
7. Zero setting and power off button
8. Battery cover
9. Depth measuring blade
10. Step-measuring faces

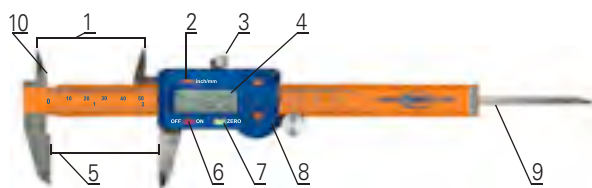

## PREPARATIONS

1. Slider can be removed only after the locking screw (No. 3 item of the Nomenclature) is loosened.
  2. Wipe clean all the measuring faces and caliper bar. No organic solutions are allowed.
  3. Check to see if all the buttons, switches, and LCD display respond well.
2. Basic measuring methods.
  1. Loosen the locking screw.
  2. Switch the unit on with a press on "ON" button. Then select the unit system needed by pressing Inch/Metric button. (Each time the button is pressed inch and metric digits will be displayed alternatively.)
3. Apply normal measuring pressure on slider to close the external measuring jaws. Then press "zero" button to reset the display to zero.

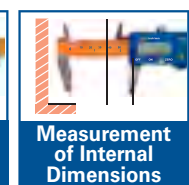
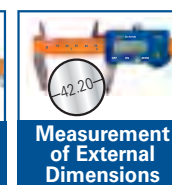
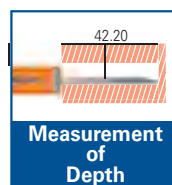

866-ASK-EPSI (866-275-3774)  
866-FAX-EPSI (866-329-3774)

57

Order online at  
[www.epsi.com](http://www.epsi.com)

**YOU ASK IT.  
WE MASK IT.®**

# K12/K22<sup>1 & 2 mil</sup> Polyimide Tape

500°F (260°C)/600°F



- **Maximum Temperature: 500°F (K12) & 600°F (K22)**
- **K12 is Thin and Conformable, Enabling Masking of Uneven Surfaces**
- **K22's High-Strength Backing Provides Superior Puncture, Tear and Abrasion Resistance**
- **Removes Cleanly without Adhesive Residue After Exposure to Heat and/or Chemicals**
- **Resistant to Chemical Attack**
- **Flame-Retardant and Excellent Electrical Insulation**

## PRODUCT DESCRIPTION

Our **K12 polyimide film tape** combines a 1.6 mil high temperature pressure sensitive adhesive with a 1.0 mil flexible carrier to create a tape product which is perfect for high temperature masking needs. Typical applications include the protection of printed circuit board gold finger contact leads during wave soldering.

Our **K22 polyimide film tape** combines a 1.5 mil high temperature pressure sensitive adhesive with a 2.0 mil flexible carrier to create a tape product which is perfect for high temperature masking needs. Typical applications include the electrical insulation of high temperature coils, motors and transformers meeting Class H requirements.

## TYPICAL APPLICATION

Powder Coating, E-Coating, Wave Soldering, Circuit Board Insulation, and Hot Air Leveling. The product is UL approved for use in the electrical insulation applications meeting class H requirements.

## SHELF LIFE

Shelf life is 6 months from date of shipment when stored in a cool dry place below 76°F (24°C). Rolls should be stored end up.

## CONSTRUCTION

	K12	K22
Total Thickness	2.6 mils	3.5 mils
Adhesive Thickness	1.6 mils	1.5 mils
Carrier Thickness	1.0 mil	2.0 mils
Adhesive Type	Silicone	Silicone
Carrier Type	Polyimide	Polyimide
Color	Amber	Amber

## SPECIFICATIONS

	K12	K22
Maximum Temperature (F)	500°	600°
Tensile Strength (lbs/inch)	30	55
Elongation (%)	60	60
Peel Adhesion (oz/inch)	25	22
Dielectric Strength (volts)	6800	12000
Government Specifications	UL Number E197661	NA

500°F & 600°F intermittent rating. Contact an EPSI representative for recommendations on tapes for continuous or extended use. Many factors can affect the use and performance of a product in a particular application. This product should be tested to determine the suitability for its intended use.



866-ASK-EPSI (866-275-3774)  
866-FAX-EPSI (866-329-3774)

58

Order online at  
[www.epsi.com](http://www.epsi.com)

**YOU ASK IT.  
WE MASK IT.®**

## K12 SERIES

PART NUMBER	WIDTH (in)	STANDARD		METRIC		CASE QTY
		WIDTH (in)	LENGTH (yds)	WIDTH (mm)	LENGTH (m)	
K12-00032	0.125	1/8	36	3.2	33	192
K12-00064	0.250	1/4	36	6.4	33	96
K12-00095	0.375	3/8	36	9.5	33	64
K12-00127	0.500	1/2	36	12.7	33	48
K12-00159	0.625	5/8	36	15.9	33	40
K12-00190	0.750	3/4	36	19.0	33	32
K12-00254	1.000	1	36	25.4	33	24
K12-00286	1.125	1 1/8	36	28.6	33	20
K12-00318	1.250	1 1/4	36	31.8	33	20
K12-00381	1.500	1 1/2	36	38.1	33	16
K12-00508	2.000	2	36	50.8	33	12
K12-00762	3.000	3	36	76.2	33	8
K12-01016	4.000	4	36	101.6	33	8
K12-01524	6.000	6	36	152.4	33	4

## K22 SERIES

PART NUMBER	WIDTH (in)	STANDARD		METRIC		CASE QTY
		WIDTH (in)	LENGTH (yds)	WIDTH (mm)	LENGTH (m)	
K22-00032	0.125	1/8	36	3.2	33	192
K22-00064	0.250	1/4	36	6.4	33	96
K22-00095	0.375	3/8	36	9.5	33	64
K22-00127	0.500	1/2	36	12.7	33	48
K22-00159	0.625	5/8	36	15.9	33	40
K22-00190	0.750	3/4	36	19.0	33	32
K22-00254	1.000	1	36	25.4	33	24
K22-00381	1.500	1 1/2	36	38.1	33	16
K22-00508	2.000	2	36	50.8	33	12
K22-00762	3.000	3	36	76.2	33	8
K22-01016	4.000	4	36	101.6	33	8

■ Other sizes available upon request.

■ Current pricing available at [www.epsi.com](http://www.epsi.com)



866-ASK-EPSI (866-275-3774)  
866-FAX-EPSI (866-329-3774)

59

Order online at  
[www.epsi.com](http://www.epsi.com)

**YOU ASK IT.  
WE MASK IT.®**

# KD22 2 mil Polyimide Discs

600°F (315°C)



- Maximum Temperature: 600°F
- Total Thickness: 3.5 mils (w/o liner)
- High-Strength Backing Provides Superior Puncture, Tear and Abrasion Resistance
- Removes Cleanly After Use
- Resistant to Chemical Attack
- Flame-Retardant
- Excellent Electrical Insulation

## PRODUCT DESCRIPTION

KD22 is a 2.0 mil thick polyimide film, single coated with a high-performance silicone pressure sensitive adhesive. Tape is laminated and discs are rotary die-cut on a specially formulated fluorosilicone liner.

## TYPICAL APPLICATION

Powder Coating, E-Coating, Wave Soldering, Circuit Board Insulation. Electrical insulation of various high temperature coils, motors, and transformers meeting class H Requirements.

## CONSTRUCTION

Total Thickness	3.5 mils (w/o liner)
Adhesive Thickness	1.5 mils
Carrier Thickness	2.0 mils
Adhesive Type	Silicone
Carrier Type	Polyimide
Color	Amber

## SPECIFICATIONS

Maximum Temperature (F)	600
Tensile Strength (lbs/inch)	55
Elongation (%)	60
Peel Adhesion (oz/inch)	22
Dielectric Strength (volts)	12000

Our KD22 polyimide discs combine 1.5 mils of high temperature pressure sensitive silicone adhesive with a 2.0 mil flexible carrier to create a tape product which is perfect for high temperature masking needs. Typical applications include the electrical insulation of high temperature coils, motors and transformers meeting Class H requirements.

## SHELF LIFE

Shelf life is 6 months from date of shipment when stored in a cool dry place below 76°F (24°C). Rolls should be stored end up in their original packaging.

600°F intermittent rating. Contact an EPSI representative for recommendations on tapes for continuous or extended use. Many factors can affect the use and performance of a product in a particular application. This product should be tested to determine the suitability for its intended use.



866-ASK-EPSI (866-275-3774)  
866-FAX-EPSI (866-329-3774)

60

Order online at  
[www.epsi.com](http://www.epsi.com)

**YOU ASK IT.  
WE MASK IT.®**



# KD22 SERIES

PART NUMBER	STANDARD DIAMETER (in)	DIAMETER (in)	METRIC DIAMETER (mm)	DISCS PER ROLL
KD22-0064	0.250	1/4	6.4	2000
KD22-0087	0.343	11/32	8.7	2000
KD22-0095	0.375	3/8	9.5	2000
KD22-0127	0.500	1/2	12.7	2000
KD22-0190	0.750	3/4	19.0	1000
KD22-0254	1.000	1	25.4	500
KD22-0381	1.500	1 1/2	38.1	500
KD22-0508	2.000	2	50.8	100

■ Other sizes available upon request.

■ Custom shapes and sizes can be produced in as little as 2 days.

■ All rolls over 1/2" can be produced with a slit back liner. When ordering, add "-S" to the part number. Example: KD22-0127-S

■ Current pricing available at [www.epsi.com](http://www.epsi.com)

## KW22 - Patented Wishbone Discs



US Patent #6,656,558  
 European Patent #0 960 175,  
 German Patent #698 14 358.2-08

■ Patented Pull Up Tab for Easy Placement and Removal

■ Removal Tab in Center Eliminates Shadow Effect Found in Other Designs

■ Easy-To-Find Tab; Even Under Thickest Coatings

### PRODUCT DESCRIPTION

Our U.S. and Internationally Patented KW22 polyimide discs are rapidly becoming the discs of choice for general purpose powder coating applications. Easy grip tab aids in proper disc placement. Eliminate the "hunt" for buried discs that cause rework; the easy-to-find tab makes locating and removing the disc quick and free from surface marring. KW22 discs are cut with high-precision rotary tooling.



## KW22 SERIES

Patented

PART NUMBER	STANDARD DIAMETER (in)	DIAMETER (in)	METRIC DIAMETER (mm)	DISCS PER ROLL
KW22-0127	0.500	1/2	12.7	500
KW22-0159	0.625	5/8	15.9	500
KW22-0190	0.750	3/4	19.0	500
KW22-0254	1.000	1	25.4	500
KW22-0381	1.500	1 1/2	38.1	500
KW22-0508	2.000	2	50.8	250

■ Other sizes available upon request.

■ Current pricing available at [www.epsi.com](http://www.epsi.com)



866-ASK-EPSI (866-275-3774)  
 866-FAX-EPSI (866-329-3774)

Order online at [www.epsi.com](http://www.epsi.com)



# B12 Blue Poly Tape

350°F (175°C)



■ Extremely Conformable

■ Good Chemical Resistance

■ Prevents Leakage

■ Removes Cleanly After Use

## PRODUCT DESCRIPTION

Our B12 blue polyester tape is ideal for general powder coating applications; it is the industry standard for conformable polyesters. B12 removes cleanly from surfaces without leaving a residue, and is well-suited for applications such as taping off large surfaces, general purpose die cutting, PC board masking, and sharp edge masking.

## SHELF LIFE

Shelf life is 6 months from date of shipment when stored in a cool dry place below 76°F (24°C). Rolls should be stored on end.

## B12 SERIES

## SPECIFICATIONS

Maximum Temperature (F)	350
Tensile Strength (lbs/inch)	22
Elongation (%)	80
Peel Adhesion (oz/inch)	25
Dielectric Strength (volts)	5000

## CONSTRUCTION

Total Thickness	3.0 mils
Adhesive Thickness	2.0 mils
Carrier Thickness	1.0 mils
Adhesive Type	Silicone
Carrier Type	Polyester
Color	Light Blue

PART NUMBER	WIDTH (in)	STANDARD		METRIC		CASE QTY
		WIDTH (in)	LENGTH (yds)	WIDTH (mm)	LENGTH (m)	
B12-00127	0.500	1/2	72	12.7	66	48
B12-00190	0.750	3/4	72	19.0	66	32
B12-00254	1.000	1	72	25.4	66	24
B12-00381	1.500	1 1/2	72	38.1	66	16
B12-00508	2.000	2	72	50.8	66	12
B12-00635	2.500	2 1/2	72	63.5	66	8
B12-00762	3.000	3	72	76.2	66	8

■ Other sizes available upon request.

■ Current pricing available at [www.epsi.com](http://www.epsi.com)

350°F intermittent rating. Contact an EPSI representative for recommendations on tapes for continuous or extended use. Many factors can affect the use and performance of a product in a particular application. This product should be tested to determine the suitability for its intended use.



866-ASK-EPSI (866-275-3774)  
866-FAX-EPSI (866-329-3774)

62

Order online at [www.epsi.com](http://www.epsi.com)

**YOU ASK IT.  
WE MASK IT.®**

# D12 Red Poly Tape

350°F (175°C)



■ Extremely Conformable

■ Good Chemical Resistance

■ Preshrunk Film

■ Removes Cleanly After Use

## PRODUCT DESCRIPTION

Our D12 red polyester tape is the industry standard for immersion coating applications. Its thin carrier thickness and high adhesion properties make it an ideal candidate where plating, anodizing and E-Coating is used, or where a moisture proof seal is required.

## SHELF LIFE

Shelf life is 6 months from date of shipment when stored in a cool dry place below 76°F (24°C). Rolls should be stored on end.

## SPECIFICATIONS

Maximum Temperature (F)	350
Tensile Strength (lbs/inch)	30
Elongation (%)	120
Peel Adhesion (oz/inch)	25

## CONSTRUCTION

Total Thickness	3.7 mils
Adhesive Thickness	2.7 mils
Carrier Thickness	1.0 mils
Adhesive Type	Silicone
Carrier Type	Polyester
Color	Red

## D12 SERIES

PART NUMBER	WIDTH (in)	STANDARD WIDTH (in)	LENGTH (yds)	METRIC		CASE QTY
				WIDTH (mm)	LENGTH (m)	
D12-00127	0.500	1/2	72	12.7	66	48
D12-00190	0.750	3/4	72	19.0	66	32
D12-00254	1.000	1	72	25.4	66	24
D12-00381	1.500	1 1/2	72	38.1	66	16
D12-00508	2.000	2	72	50.8	66	12

■ Other sizes available upon request.

■ Current pricing available at [www.epsi.com](http://www.epsi.com)

350°F intermittent rating. Contact an EPSI representative for recommendations on tapes for continuous or extended use. Many factors can affect the use and performance of a product in a particular application. This product should be tested to determine the suitability for its intended use.



866-ASK-EPSI (866-275-3774)  
866-FAX-EPSI (866-329-3774)

63

Order online at [www.epsi.com](http://www.epsi.com)

**YOU ASK IT.  
WE MASK IT.®**

# C11 Medium/Hi-Temp Crepe Tape

300°F (150°C)



- Straight, Clean Paint-Break Line
- Excellent Quick Stick but with smooth unwind
- Excellent adhesion to metals, rubbers and plastics
- Resists Paint Flaking upon Removal

## PRODUCT DESCRIPTION

A more economical alternative to our C21 product, C11 was designed for the auto, coach and bus industry as a professional grade medium to high temp smooth crepe masking tape. Its high performance rubber adhesive is designed for clean removal from a variety of surfaces after exposure to oven temperatures up to 300F. C11's easy unwind and smooth crepe backing makes it easy to work with and provide excellent conformability to irregular surfaces.

## CONSTRUCTION

Total Thickness 6.1 mils  
 Adhesive Type Rubber/ Resin Adhesive  
 Carrier Type Smooth Crepe Paper

## SPECIFICATIONS

Maximum Temperature (F) 300  
 Tensile Strength (lbs/inch) 25  
 Elongation (%) 10  
 Peel Adhesion (oz/inch) 36  
 Meets ASTM D6123/D6123M-97

## SHELF LIFE

To obtain best performance, use this product within one year from the date manufactured and store under normal conditions of 70°F (21°C) and 50% Relative Humidity in the original carton.

## C11 SERIES

PART NUMBER	WIDTH (in)	STANDARD		METRIC		CASE QTY
		WIDTH (in)	LENGTH (yds)	WIDTH (mm)	LENGTH (m)	
C11-00127	0.500	1/2	60	12.7	55	48
C11-00190	0.750	3/4	60	19.0	55	32
C11-00254	1.000	1	60	25.4	55	24
C11-00381	1.500	1 1/2	60	38.1	55	16
C11-00508	2.000	2	60	50.8	55	12
C11-00762	3.000	3	60	76.2	55	8
C11-01016	4.000	4	60	101.6	55	8

■ Other sizes available upon request.

■ Current pricing available at [www.epsi.com](http://www.epsi.com)

300°F intermittent rating. Contact an EPSI representative for recommendations on tapes for continuous or extended use. Many factors can affect the use and performance of a product in a particular application. This product should be tested to determine the suitability for its intended use.



866-ASK-EPSI (866-275-3774)  
 866-FAX-EPSI (866-329-3774)

64

Order online at [www.epsi.com](http://www.epsi.com)

**YOU ASK IT.  
 WE MASK IT.®**

# C21 Hi-Temp Crepe Tape [PG-21]

325°F (165°C)



- Straight, Clean Paint-Break Line
- Highly Conformable and Flexible
- Tear Resistant; Solvent Resistant
- Resists Paint Flaking upon Removal

## PRODUCT DESCRIPTION

Our C21 is the industry standard in high performance crepe tapes for low temp powder coating and liquid top coat. It is designed for clean removal from a variety of surfaces after exposure to oven temperatures up to 325°F. C21 performs well in wet strip applications. Its easy handling, smooth crepe backing exhibits high strength and excellent conformability to irregular surfaces, and exceptional cornering characteristics.

## CONSTRUCTION

Total Thickness 7.3 mils  
 Adhesive Type Rubber/ Resin Adhesive  
 Carrier Type Fine Structured Crepe Paper

## SPECIFICATIONS

Maximum Temperature (F) 325  
 Tensile Strength (lbs/inch) 26  
 Elongation (%) 10  
 Peel Adhesion (oz/inch) 28

## SHELF LIFE

To obtain best performance, use this product within one year from the date manufactured and store under normal conditions of 70°F (21°C) and 50% Relative Humidity in the original carton.

## C21 SERIES

PART NUMBER	WIDTH (in)	STANDARD		METRIC		CASE QTY
		WIDTH (in)	LENGTH (yds)	WIDTH (mm)	LENGTH (m)	
C21-00064	0.250	1/4	60	6.4	55	96
C21-00095	0.375	3/8	60	9.5	55	64
C21-00127	0.500	1/2	60	12.7	55	48
C21-00190	0.750	3/4	60	19.0	55	32
C21-00254	1.000	1	60	25.4	55	24
C21-00381	1.500	1 1/2	60	38.1	55	16
C21-00508	2.000	2	60	50.8	55	12
C21-00635	2.500	2 1/2	60	63.5	55	8
C21-00762	3.000	3	60	76.2	55	8
C21-01016	4.000	4	60	101.6	55	8
C21-01270	5.000	5	60	127.0	55	4
C21-01524	6.000	6	60	152.4	55	4

■ Other sizes available upon request.

■ Current pricing available at [www.epsi.com](http://www.epsi.com)

325°F intermittent rating. Contact an EPSI representative for recommendations on tapes for continuous or extended use. Many factors can affect the use and performance of a product in a particular application. This product should be tested to determine the suitability for its intended use.



866-ASK-EPSI (866-275-3774)  
 866-FAX-EPSI (866-329-3774)

65

Order online at [www.epsi.com](http://www.epsi.com)

**YOU ASK IT.  
 WE MASK IT.®**



# CD21 Hi-Temp Crepe Discs [PG-21]

325°F (165°C)

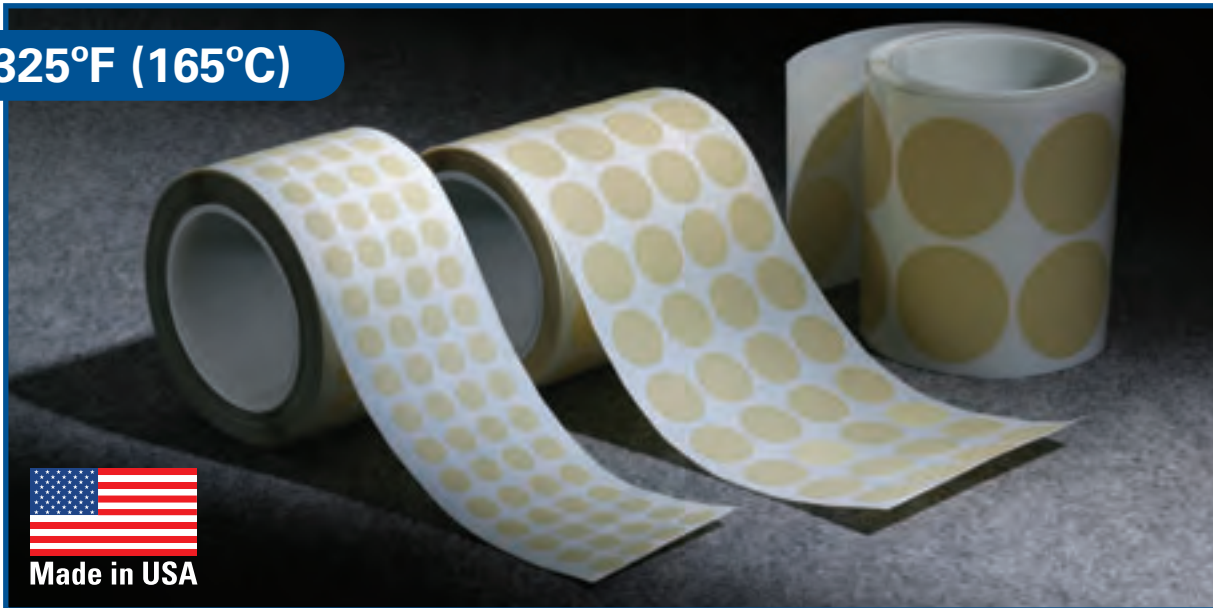

- Maximum Temperature: 325°F
- Total Thickness: 7.3 mils (w/o liner)
- Smooth to Touch and Easy to Work with
- Clean Paint Break-Line
- Highly Conformable and Flexible
- Tear Resistant; Solvent Resistant
- Resists Paint Flaking upon Removal

## PRODUCT DESCRIPTION

CD21 (PG-21) is a tan colored crepe paper masking tape with a rubber resin blended adhesive. Tape is laminated and discs are rotary die-cut on a specially formulated paper release liner.

## TYPICAL APPLICATION

General masking applications in the industrial market including low temperature Powder Coating and Liquid Spray applications.

## CONSTRUCTION

Total Thickness	7.3 mils (w/o liner)
Adhesive Type	Rubber/ Resin Adhesive
Carrier Type	Fine Structured Crepe Paper
Color	Tan; Kraft

## SPECIFICATIONS

Maximum Temperature (F)	325
Tensile Strength (lbs/inch)	26
Elongation (%)	10
Peel Adhesion (oz/inch)	28

Our CD21 (PG-21) is the industry standard in high performance crepe discs. They are high temperature pressure-sensitive masking discs designed for clean removal from a variety of surfaces after exposure to oven temperatures up to 325°F. CD21 (PG-21) discs perform well in wet strip applications.

## SHELF LIFE

To obtain best performance, use this product within one year from the date manufactured and store under normal conditions of 70°F(21°C) and 50% Relative Humidity in the original packaging.

325°F intermittent rating. Contact an EPSI representative for recommendations on tapes for continuous or extended use. Many factors can affect the use and performance of a product in a particular application. This product should be tested to determine the suitability for its intended use.



866-ASK-EPSI (866-275-3774)  
866-FAX-EPSI (866-329-3774)

66

Order online at  
[www.epsi.com](http://www.epsi.com)

**YOU ASK IT.  
WE MASK IT.®**

# CD21 SERIES

[PG-21]

PART NUMBER	STANDARD DIAMETER (in)	DIAMETER (in)	METRIC DIAMETER (mm)	DISCS PER ROLL
CD21-0032	0.125	1/8	3.2	5000
CD21-0048	0.188	3/16	4.8	5000
CD21-0064	0.250	1/4	6.4	5000
CD21-0079	0.313	5/16	7.9	5000
CD21-0095	0.375	3/8	9.5	5000
CD21-0111	0.438	7/16	11.1	5000
CD21-0127	0.500	1/2	12.7	5000
CD21-0143	0.563	9/16	14.3	5000
CD21-0159	0.625	5/8	15.9	5000
CD21-0190	0.750	3/4	19.0	4000
CD21-0222	0.875	7/8	22.2	2000
CD21-0254	1.000	1	25.4	2000
CD21-0286	1.125	1 1/8	28.6	2000
CD21-0318	1.250	1 1/4	31.8	2000
CD21-0349	1.375	1 3/8	34.9	2000
CD21-0381	1.500	1 1/2	38.1	2000
CD21-0445	1.750	1 3/4	44.5	1000
CD21-0508	2.000	2	50.8	500
CD21-0572	2.250	2 1/4	57.2	500
CD21-0635	2.500	2 1/2	63.5	500
CD21-0699	2.750	2 3/4	69.9	500
CD21-0762	3.000	3	76.2	500
CD21-0889	3.500	3 1/2	88.9	500
CD21-1016	4.000	4	101.6	250
CD21-1079	4.250	4 1/4	107.9	250
CD21-1143	4.500	4 1/2	114.3	250
CD21-1270	5.000	5	127.0	250
CD21-1524	6.000	6	152.4	250
CD21-2032	8.000	8	203.2	100

- Other sizes available upon request.
- Custom shapes and sizes can be produced in as little as 2 days.
- All rolls over 1/2" can be produced with a slit back liner. When ordering, add "-S" to the part number.  
Example: CD21-0127-S
- Current pricing available at [www.epsi.com](http://www.epsi.com)



866-ASK-EPSI (866-275-3774)  
866-FAX-EPSI (866-329-3774)

67

Order online at  
[www.epsi.com](http://www.epsi.com)

**YOU ASK IT.  
WE MASK IT.**

# PPFC21 Hi-Temp Crepe Tape With Film [PG-21]

325°F (165°C)

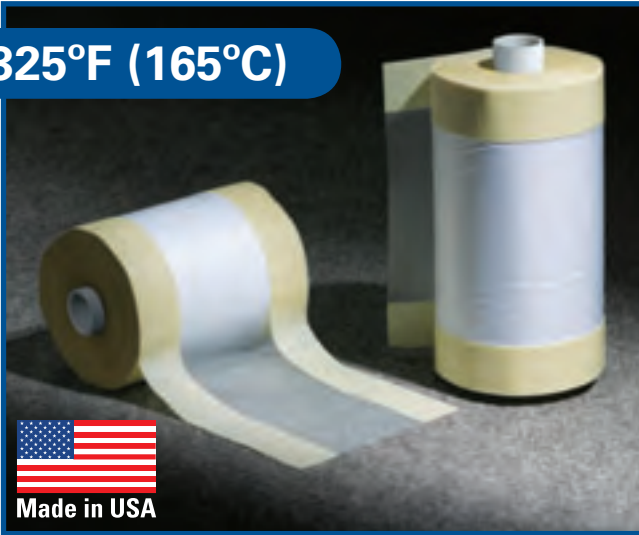

- Straight, Clean Paint-Break Line
- Highly Conformable and Flexible
- Tear Resistant; Solvent Resistant
- Resists Paint Flaking upon Removal

## PRODUCT DESCRIPTION

Our C21 is the industry standard in high performance crepe tapes for low temp powder coating and liquid top coat. It is designed for clean removal from a variety of surfaces after exposure to oven temperatures up to 325°F. C21 performs well in wet strip applications. Its easy handling, smooth crepe backing exhibits high strength and excellent conformability to irregular surfaces, and exceptional cornering characteristics.

## CONSTRUCTION

Total Thickness 7.3 mils  
Adhesive Type Rubber/ Resin Adhesive  
Carrier Type Fine Structured Crepe Paper

## SPECIFICATIONS

Maximum Temperature (F) 325  
Tensile Strength (lbs/inch) 26  
Elongation (%) 10  
Peel Adhesion (oz/inch) 28

## SHELF LIFE

To obtain best performance, use this product within one year from the date manufactured and store under normal conditions of 70°F (21°C) and 50% Relative Humidity in the original carton.

## CF21 SERIES

PART NUMBER	STANDARD		METRIC	
	WIDTH (in)	LENGTH (yds)	WIDTH (mm)	LENGTH (m)
PPFC21-01524	6.000	25	152.4	22.86
PPFC21-02032	8.000	25	203.2	22.86
PPFC21-02540	10.000	25	254.0	22.86
PPFC21-03048	12.000	25	304.8	22.86
PPFC21-03556	14.000	25	355.6	22.86

■ Other sizes available upon request.

■ Current pricing available at [www.epsi.com](http://www.epsi.com)

325°F intermittent rating. Contact an EPSI representative for recommendations on tapes for continuous or extended use. Many factors can affect the use and performance of a product in a particular application. This product should be tested to determine the suitability for its intended use.



866-ASK-EPSI (866-275-3774)  
866-FAX-EPSI (866-329-3774)

68

Order online at  
[www.epsi.com](http://www.epsi.com)

**YOU ASK IT.  
WE MASK IT.®**

# S10/S20/S30 Silicone Self-Fusing Tape

600°F (315°C)



- Maximum Temperature: 600°F
- Excellent Insulation Value up to 12,000 Volts
- No Adhesive; Only Sticks to Itself
- Waterproof
- Form Fitting

## PRODUCT DESCRIPTION

Our high temperature silicone self-fusing tape line (S10/S20/S30) has no adhesive, leaves no residue, and fuses to itself in 24 hours to form a permanent watertight seal. It is ideal for high temperature applications such as electrical insulation, splicing, and cable harnesses.

## TYPICAL APPLICATION

Powder Coating, E-Coating, Plating, Anodizing and Harness Wrapping. Additional uses include Automotive Repair, Lead Termination, Home Repairs, Marine Applications, and as a Grip Tape.

## SHELF LIFE

Shelf life is 6 months from date of shipment when stored in a cool dry place below 76°F (24°C). Rolls should be stored on end.

## SPECIFICATIONS

Temperature Range (F)	Continuous: -65 to 500°F; Intermittent: -85 to 600°F
Tensile Strength (PSI)	700 PSI Minimum (ASTM D-412)
Elongation (%)	300
Tear Resistance (PSI)	85
Durometer (Shore A)	50 (Room Cured)
Dielectric Strength (VPM)	200 - 400
Dielectric Constant (1 KHz)	2.95
Dissipation Factor (1KHz)	<.0004
Insulation Resistance (ohms/cm)	3 X 10 <sup>14</sup>
Moisture Absorption	3% Max. by weight
Government Specifications	Meets or Exceeds A-A-59163 (Supersedes mils I-46852C)

## S10 SERIES

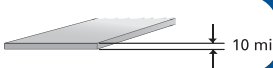
PART NUMBER	COLOR	WIDTH (in)	STANDARD		METRIC		CASE QTY	Flat 
			WIDTH (in)	LENGTH (yds)	WIDTH (mm)	LENGTH (m)		
S10-00127-Y	GREY	0.500	1/2	18	12.7	16	8	*OTHER COLORS AVAILABLE
S10-00191-Y	GREY	0.750	3/4	18	19.1	16	8	
S10-00254-Y	GREY	1.000	1	18	25.4	16	8	

## S20 SERIES

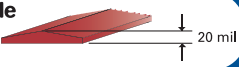
PART NUMBER	COLOR	WIDTH (in)	STANDARD		METRIC		CASE QTY	Triangle 
			WIDTH (in)	LENGTH (yds)	WIDTH (mm)	LENGTH (m)		
S20-00254-F	RUSTY	1.000	1	12	25.4	11	8	*OTHER COLORS AVAILABLE
S20-00381-F	RUSTY	1.500	1 1/2	12	38.1	11	8	
S20-00508-F	RUSTY	2.000	2	12	50.8	11	8	

## S30 SERIES

PART NUMBER	COLOR	WIDTH (in)	STANDARD		METRIC		CASE QTY	Triangle 
			WIDTH (in)	LENGTH (yds)	WIDTH (mm)	LENGTH (m)		
S30-00254-B	BLACK	1.000	1	12	25.4	11	8	*OTHER COLORS AVAILABLE
S30-00381-B	BLACK	1.500	1 1/2	12	38.1	11	8	
S30-00508-B	BLACK	2.000	2	12	50.8	11	8	

600°F intermittent rating. Contact an EPSI representative for recommendations on tapes for continuous or extended use. Many factors can affect the use and performance of a product in a particular application. This product should be tested to determine the suitability for its intended use.



866-ASK-EPSI (866-275-3774)  
866-FAX-EPSI (866-329-3774)

69

Order online at  
[www.epsi.com](http://www.epsi.com)



# F12 Fiberglass [Glass Cloth] Tape

500°F (260°C)



- Maximum Temperature: 500°F
- Total Thickness: 7.0 mils
- Maximum Resistance to Flagging and Varnish Solvents
- High Tensile Strength
- Non-Corrosive
- Extremely High Abrasive Resistance; Frey-Free Edges

## PRODUCT DESCRIPTION

F12 is a fiberglass reinforced cloth substrate with a proprietary Therm-X silicone adhesive system

## TYPICAL APPLICATION

Powder Coating, Plasma Spray, Thermal Spray, Grit and Shot Blasting

## SHELF LIFE

Shelf life is 6 months from date of shipment when stored in a cool dry place below 76°F (24°C). Rolls should be stored end up.

## Construction

Total Thickness	7.0 mils
Adhesive Thickness	2.0 mils
Carrier Thickness	5.0 mils
Adhesive Type	Silicone
Carrier Type	Glass Cloth
Color	White

## SPECIFICATIONS

Maximum Temperature (F)	500
Tensile Strength (lbs/inch)	170
Elongation (%)	8
Peel Adhesion (oz/inch)	40
Dielectric Strength (volts)	3000
Insulation Resistance (meg ohms)	1500

Our F12 fiberglass tape combines a 2.0 mil Silicone adhesive with 5.0 mil glass cloth carrier to create a tape product which is ideal for shot blasting, grit blasting, thermal spray and plasma spray applications. Typically, fiberglass tape is used to protect machined surfaces during shot blasting applications. F12 is an excellent choice in thermal spray and plasma spray applications due to its excellent resistance to intense heat. Not recommended for applications involving immersion coating due to the porous nature of the glass cloth backing.

500°F intermittent rating. Contact an EPSI representative for recommendations on tapes for continuous or extended use. Many factors can affect the use and performance of a product in a particular application. This product should be tested to determine the suitability for its intended use.



866-ASK-EPSI (866-275-3774)  
866-FAX-EPSI (866-329-3774)

70

Order online at  
[www.epsi.com](http://www.epsi.com)

**YOU ASK IT.  
WE MASK IT.®**



## F12 SERIES

PART NUMBER	WIDTH (in)	STANDARD		METRIC		CASE QTY
		WIDTH (in)	LENGTH (yds)	WIDTH (mm)	LENGTH (m)	
F12-00095	0.375	3/8	36	9.5	33	64
F12-00127	0.500	1/2	36	12.7	33	48
F12-00190	0.750	3/4	36	19.0	33	32
F12-00254	1.000	1	36	25.4	33	24
F12-00318	1.250	1 1/4	36	31.8	33	20
F12-00381	1.500	1 1/2	36	38.1	33	16
F12-00508	2.000	2	36	50.8	33	12
F12-00635	2.500	2 1/2	36	63.5	33	8
F12-00762	3.000	3	36	76.2	33	8
F12-01016	4.000	4	36	101.6	33	8
F12-01270	5.000	5	36	127.0	33	4

■ Other sizes available upon request.

■ Current pricing available at [www.epsi.com](http://www.epsi.com)



### DISCS:

■ Other sizes available upon request.

■ Please call an EPSI representative for pricing and availability.

## FD12 SERIES

PART NUMBER	STANDARD		METRIC DIAMETER (mm)	DISCS PER ROLL
	DIAMETER (in)	DIAMETER (in)		
FD12-0127	0.500	1/2	12.7	2000
FD12-0190	0.750	3/4	19.0	1000
FD12-0254	1.000	1	25.4	500
FD12-0381	1.500	1 1/2	38.1	500
FD12-0508	2.000	2	50.8	100

■ Other sizes available upon request.

■ Custom shapes and sizes can be produced in as little as 2 days.

■ All rolls over 1/2" can be produced with a slit back liner. When ordering, add "-S" to the part number.

Example: FD12-0127-S

■ Current pricing available at [www.epsi.com](http://www.epsi.com)



866-ASK-EPSI (866-275-3774)  
866-FAX-EPSI (866-329-3774)

71

Order online at  
[www.epsi.com](http://www.epsi.com)

**YOU ASK IT.  
WE MASK IT.®**

# M10 Aluminium Tape

325°F (165°C)

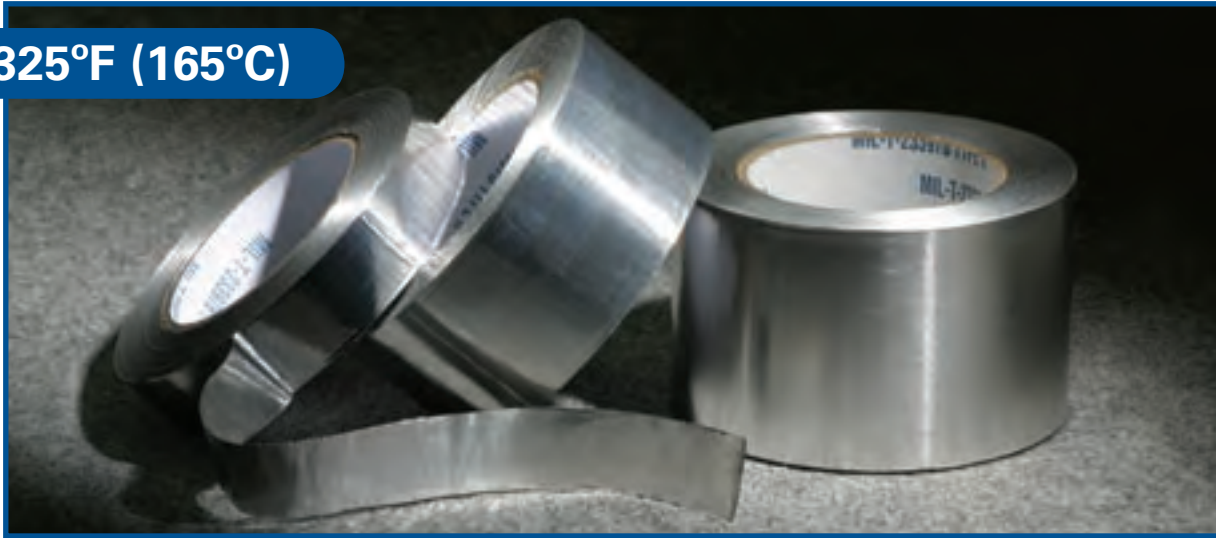

- Maximum Temperature: 325°F
- Malleable Foil Conforms Well to Irregular Surfaces
- High Reflectivity Assures Effective Heat, Light Interference
- Effective as Electrical Isolation Shielding.

## PRODUCT DESCRIPTION

3.0 mil high strength self wound dead soft Aluminum Foil coated with an aggressive acrylic adhesive system to create a superior bond.

## TYPICAL APPLICATION

Waterproofing, vapor barrier, air leakage protection, metal patching and sound dampening. As a sealing system in refrigerated applications and microwave ovens. Electrical isolation shielding. Masking in paint stripping and electroplating.

## CONSTRUCTION

Total Thickness	5.0 mils
Adhesive Thickness	2.0 mils
Carrier Thickness	3.0 mils
Adhesive Type	Acrylic
Carrier Type	Soft Aluminum Foil
Color	Silver

## SPECIFICATIONS

Maximum Temperature (F)	325
Tensile Strength (lbs/inch)	28
Elongation (%)	5.5
Peel Adhesion (oz/inch)	72
Government Specifications:	Meets Specifications for LT-80-B; MIL-T-23397B, Amendment 2, Type II

## M10 SERIES

PART NUMBER	WIDTH (in)	STANDARD		METRIC		CASE QTY
		WIDTH (in)	LENGTH (yds)	WIDTH (mm)	LENGTH (m)	
M10-00127	0.500	1/2	36	12.7	33	72
M10-00190	0.750	3/4	36	19.1	33	48
M10-00254	1.000	1	36	25.4	33	36
M10-00381	1.500	1 1/2	36	38.1	33	24
M10-00508	2.000	2	36	50.8	33	24

- Other sizes available upon request.
- Current pricing available at [www.epsi.com](http://www.epsi.com)

325°F intermittent rating. Contact an EPSI representative for recommendations on tapes for continuous or extended use. Many factors can affect the use and performance of a product in a particular application. This product should be tested to determine the suitability for its intended use.



866-ASK-EPSI (866-275-3774)  
866-FAX-EPSI (866-329-3774)

72

Order online at  
[www.epsi.com](http://www.epsi.com)

**YOU ASK IT.  
WE MASK IT.®**

# P12 Lead Foil Tape

225°F (105°C)



■ Maximum Temperature: 225°F

■ Good Solvent Resistance

■ Excellent Adhesion to a Wide Variety of Surfaces

■ Highly Malleable

## PRODUCT DESCRIPTION

100% pure lead foil with a synthetic rubber adhesive; wound with a liner.

## TYPICAL APPLICATION

Used for stop off masking during electroplating, chemical milling, paint stripping, and where a moisture proof seal is required. Also used as an electromagnetic and radio frequency shield.

## CONSTRUCTION

Total Thickness	6.5 mils
Adhesive Thickness	1.5 mils
Carrier Thickness	5.0 mils
Adhesive Type	Blended Rubber
Carrier Type	Lead Foil
Color	Silver

## SPECIFICATIONS

Maximum Temperature (F)	225
Tensile Strength (lbs/inch)	23
Elongation (%)	30
Peel Adhesion (oz/inch)	96
Government Specifications	HH-T-29A, Amendment 2

## P12 SERIES

PART NUMBER	WIDTH (in)	STANDARD WIDTH (in)	LENGTH (yds)	WIDTH (mm)	METRIC LENGTH (m)	CASE QTY
P12-00127	0.500	1/2	36	12.7	33	18
P12-00190	0.750	3/4	36	19.1	33	12
P12-00254	1.000	1	36	25.4	33	9

■ Other sizes available upon request.

■ Current pricing available at [www.epsi.com](http://www.epsi.com)

225°F intermittent rating. Contact an EPSI representative for recommendations on tapes for continuous or extended use. Many factors can affect the use and performance of a product in a particular application. This product should be tested to determine the suitability for its intended use.



866-ASK-EPSI (866-275-3774)  
866-FAX-EPSI (866-329-3774)

73

Order online at  
[www.epsi.com](http://www.epsi.com)

**YOU ASK IT.  
WE MASK IT.®**

# V12 Electroplating Vinyl Tape

176°F (80°C)



- Maximum Temperature: 176°F
- Total Thickness: 6.5 mils
- Effective Vapor and Moisture Barrier
- Extremely Conformable
- Durable and Highly Resistant to Oil, Acid, Alkaline and Corrosive Chemicals
- Excellent Adhesion to Metals and Plastics
- Meets Government Specifications H-H-T-0025, Amendment 2.

## PRODUCT DESCRIPTION

6.5 mil conformable self-wound soft PVC Vinyl with a rubber adhesive.

## TYPICAL APPLICATION

Used as a masking tape in electroplating operations. Designed for use with PCB terminal zone contacts during plating; as a protection tape for shot peening.

## SHELF LIFE

To obtain best performance, use this product within 18 months from date of manufacture and store under normal conditions of 60 to 80°F (16 to 27°C) in the original carton.

## CONSTRUCTION

Total Thickness	6.5 mils
Adhesive Type	Rubber Based
Carrier Type	Soft PVC (non-rigid vinyl)
Color	Cream

## SPECIFICATIONS

Maximum Temperature (F)	176
Tensile Strength (lbs/inch)	25
Elongation (%)	200
Peel Adhesion (oz/inch)	30
Moisture Absorption	Less than 1.5%
Moisture Vapor	Less than 2.5% (gm/100 sq in/24hrs)
Government Specifications	Meets Government specifications H-H-T-0025, Amendment 2.

**Note:** DO NOT peel off until temperature cools down to 140°F to 158F (60°C to 70°C)

Our V12 cream vinyl tape is extremely conformable and resistant to aging, sun, water, oils, acids and corrosive chemicals. It has excellent adhesion to metals and plastics, making it the ideal choice in any plating application. The adhesive backing provides excellent solvent and chemical resistance.

176°F intermittent rating. Contact an EPSI representative for recommendations on tapes for continuous or extended use. Many factors can affect the use and performance of a product in a particular application. This product should be tested to determine the suitability for its intended use.



866-ASK-EPSI (866-275-3774)  
866-FAX-EPSI (866-329-3774)

74

Order online at  
[www.epsi.com](http://www.epsi.com)

**YOU ASK IT.  
WE MASK IT.®**

## V12 SERIES

PART NUMBER	WIDTH (in)	STANDARD		METRIC		CASE QTY
		WIDTH (in)	LENGTH (yds)	WIDTH (mm)	LENGTH (m)	
V12-00127	0.500	1/2	36	12.7	33	48
V12-00190	0.750	3/4	36	19.1	33	32
V12-00254	1.000	1	36	25.4	33	24
V12-00381	1.500	1 1/2	36	38.1	33	16
V12-00508	2.000	2	36	50.8	33	12

■ Other sizes available upon request.

■ Current pricing available at [www.epsi.com](http://www.epsi.com)



### DISCS:

■ Other sizes available upon request.

■ Please call an EPSI representative for pricing and availability.

## VD12 SERIES

PART NUMBER	STANDARD		METRIC DIAMETER (mm)	DISCS PER ROLL
	DIAMETER (in)	DIAMETER (in)		
VD12-0127	0.500	1/2	12.7	2000
VD12-0190	0.750	3/4	19.0	1000
VD12-0254	1.000	1	25.4	500
VD12-0381	1.500	1 1/2	38.1	500
VD12-0508	2.000	2	50.8	100

■ Custom shapes and sizes can be produced in as little as 2 days.

■ Current pricing available at [www.epsi.com](http://www.epsi.com)



866-ASK-EPSI (866-275-3774)  
866-FAX-EPSI (866-329-3774)

75

Order online at  
[www.epsi.com](http://www.epsi.com)

**YOU ASK IT.  
WE MASK IT.®**



# V10 General Purpose Vinyl Tape

176°F (80°C)



- Superior Quality with a Long Shelf-Life
- Effective Vapor and Moisture Barrier
- Highly Conformable
- Resistant to Aging, Sun, Water, Fungus, Bacteria, Oil, Acids, Alkalis and Corrosive Chemicals
- Good Abrasion, Impact and Rupture Resistance.
- Conforms to PPP-T-66E, Type 1, Class 2; A-A-1689A

## PRODUCT DESCRIPTION

Used for color coding ("write-on" capabilities); lane marking and safety coding to meet OSHA requirements; decorating, striping on vehicles, boats, and sporting equipment. Masking for Hard Chrome Plating, Electroplating, Type II and Type III Anodizing, Abrasive Blasting, Wet Painting, Fixture Wrapping, Harness and Pipe Wrapping; Duct and Joint Sealing.

## CONSTRUCTION

Total Thickness	6.0 mils
Adhesive Type	Synthetic Rubber Resin
Carrier Type	Matte surface, soft PVC
Color	Purple

## SPECIFICATIONS

Maximum Temperature (F)	176°F
Tensile Strength (lbs/inch)	16
Elongation (%)	150
Peel Adhesion (oz/inch)	22
Moisture Absorption	Less than 1.5%
Moisture Vapor	Less than 2.5% (gm/100 sq in/24hrs)
Metal Corrosion	None to Copper, Brass, Steel or Aluminum
Government Specifications	Conforms to PPP-T-66E, Type 1, Class 2; A-A-1689A

## SHELF LIFE

To obtain best performance, use this product within 18 months from date of manufacture and store under normal conditions of 60 to 80°F (16 to 27°C) and 40 to 60% Relative Humidity in the original carton.

PART NUMBER	WIDTH (in)	STANDARD WIDTH (in)	LENGTH (yds)	METRIC		CASE QTY
				WIDTH (mm)	LENGTH (m)	
V10-00127	0.500	1/2	36	12.7	33	48
V10-00190	0.750	3/4	36	19.1	33	32
V10-00254	1.000	1	36	25.4	33	24
V10-00381	1.500	1 1/2	36	38.1	33	16
V10-00508	2.000	2	36	50.8	33	12

■ Other sizes available upon request.

■ Current pricing available at [www.epsi.com](http://www.epsi.com)

176°F intermittent rating. Contact an EPSI representative for recommendations on tapes for continuous or extended use. Many factors can affect the use and performance of a product in a particular application. This product should be tested to determine the suitability for its intended use.



866-ASK-EPSI (866-275-3774)  
866-FAX-EPSI (866-329-3774)

76

Order online at [www.epsi.com](http://www.epsi.com)



# V71 Non-Adhesive Vinyl Tape

176°F (80°C)



- Extremely Conformable Matrix; Clings to Corners
- Clings Securely to Itself without Adhesive
- Durable and Highly Resistant to Oil, Acid, Alkaline and Corrosive Chemicals
- High Elongation and Good Strength
- Mask 2 to 3 Times Faster than with Adhesive

## PRODUCT DESCRIPTION

Our V71 product is a multi-purpose tape, with excellent chemical resistance and insulation properties. It is the premier choice for plating, Type II and Type III anodizing applications. Overlapping while stretching the film allows for a liquid tight seal around racks and other parts. It can also be used to replace plastisol dipping for racks. The lack of an adhesive makes V71 extremely easy and economical to apply.

## CONSTRUCTION

Total Thickness 4.0 mils  
 Carrier Type Polyvinyl Chloride Film  
 Color Yellow

## SPECIFICATIONS

Maximum Temperature (F) 176  
 Tensile Strength (lbs/inch) 11.5  
 Elongation (%) 250  
 Dielectric Strength (vpm) 1200

## SHELF LIFE

To obtain best performance, use this product within 18 months from date of manufacture and store under normal conditions of 60 to 80°F (16 to 27°C) and 40 to 60% Relative Humidity in the original carton.

PART NUMBER	WIDTH (in)	STANDARD WIDTH (in)	LENGTH (feet)	METRIC		CASE QTY
				WIDTH (mm)	LENGTH (m)	
V71-00190	0.750	3/4	250	19.0	76	48
V71-00254	1.000	1	250	25.4	76	32
V71-00381	1.500	1 1/2	250	38.1	76	24
V71-00508	2.000	2	250	50.8	76	16
V71-00762	3.000	3	250	76.2	76	12

■ Other sizes available upon request.

■ Current pricing available at [www.epsi.com](http://www.epsi.com)

176°F intermittent rating. Contact an EPSI representative for recommendations on tapes for continuous or extended use. Many factors can affect the use and performance of a product in a particular application. This product should be tested to determine the suitability for its intended use.



866-ASK-EPSI (866-275-3774)  
 866-FAX-EPSI (866-329-3774)

77

Order online at [www.epsi.com](http://www.epsi.com)

**YOU ASK IT.  
 WE MASK IT.®**

# C10 Crepe Masking Tape

**3M™**  
**2364**

**300°F (150°C)**



- **Maximum Temperature: 300°F**
- **Total Thickness: 6.5 mils (w/o liner)**
- **Good Conformability and Curve Masking**
- **Solvent Resistant**
- **Prevents Bleed-Through**
- **Sliver Resistant**
- **Good Paint Flaking Resistance**
- **Helps Minimize Rework**

## PRODUCT DESCRIPTION

C10 (2364) is a tan colored crepe paper masking tape with a natural synthetic rubber blend adhesive.

## TYPICAL APPLICATION

General masking applications in the industrial market including low temperature powder coating and liquid spray applications.

## CONSTRUCTION

Total Thickness	6.5 mils (w/o liner)
Adhesive Type	Natural/synthetic rubber blend
Carrier Type	A smooth crepe paper treated with a heat resistant saturant
Color	Tan

## SPECIFICATIONS

Temperature Range (°F)	300 (for 30 min)
Tensile Strength (lbs/inch)	30
Elongation (%)	10
Peel Adhesion (oz/inch)	36

**Note:** Should not be subjected to outdoor exposure or prolonged sunlight. Tape may become difficult to remove.

C10 (2364) general purpose crepe tape is ideal for applications where good holding power and temperature performance are required. It can be used in low temperature powder coating, as well as in wet spray applications. Due to its economical price point, C10 (2364) is an excellent solution for large, flat surfaces that require masking during wet spray.

## SHELF LIFE

To obtain best performance, use this product within one year from the date manufacture and store under normal conditions of 70°F (21°C) and 50% Relative Humidity in the original carton.

300°F intermittent rating. Contact an EPSI representative for recommendations on tapes for continuous or extended use. Many factors can affect the use and performance of a product in a particular application. This product should be tested to determine the suitability for its intended use.



866-ASK-EPSI (866-275-3774)  
866-FAX-EPSI (866-329-3774)

**78**

Order online at  
[www.epsi.com](http://www.epsi.com)

**YOU ASK IT.  
WE MASK IT.®**

<b>PART NUMBER</b>	<b>WIDTH (IN)</b>	<b>WIDTH (IN)</b>	<b>LENGTH (YDS)</b>	<b>WIDTH (MM)</b>	<b>LENGTH (M)</b>	<b>CASE QTY</b>
C10-00095	0.375	3/8	60	9.5	55	64
C10-00127	0.500	1/2	60	12.7	55	48
C10-00190	0.750	3/4	60	19.1	55	32
C10-00254	1.000	1	60	25.4	55	24
C10-00318	1.250	1 1/4	60	31.8	55	20
C10-00381	1.500	1 1/2	60	38.1	55	16
C10-00445	1.750	1 3/4	60	44.5	55	16
C10-00508	2.000	2	60	50.8	55	12
C10-00762	3.000	3	60	76.2	55	8
C10-01524	6.000	6	60	152.4	55	4

■ Current pricing and additional sizes available at [www.epsi.com](http://www.epsi.com)



866-ASK-EPSI (866-275-3774)  
866-FAX-EPSI (866-329-3774)

79

Order online at  
[www.epsi.com](http://www.epsi.com)



# C12 Crepe Masking Tape

**3M™ 2380**

**325°F (165°C)**

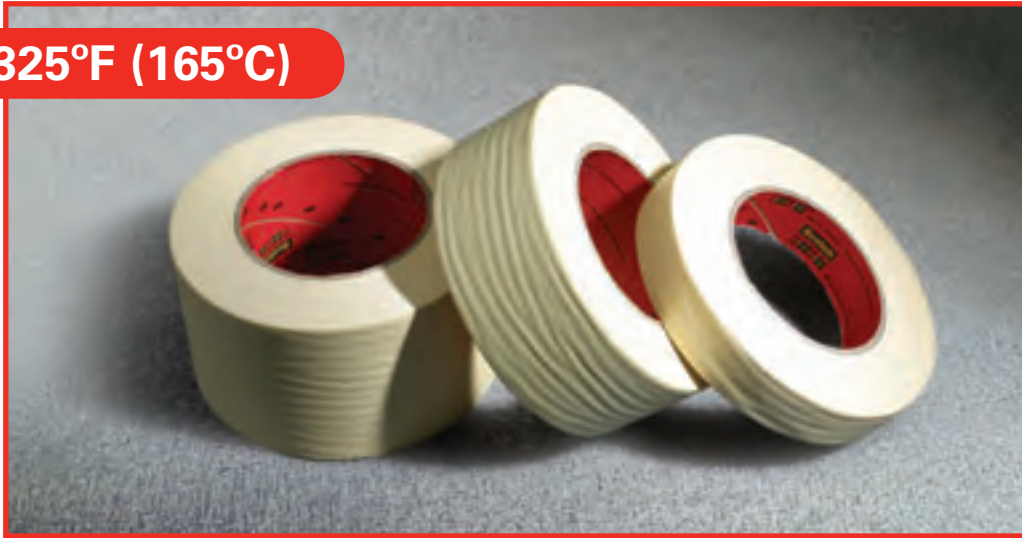

- **Maximum Temperature: 325°F**
- **Total Thickness: 7.5 mils (w/o liner)**
- **Instant Adhesion**
- **Good Holding Power**
- **Superior Adhesive Transfer Resistance**
- **Smooth; Dead Stretch**
- **Conformable**

## PRODUCT DESCRIPTION

C12 (2380) is a tan colored smooth crepe paper treated with a heat and solvent resistant saturant and a natural synthetic rubber blend adhesive.

## TYPICAL APPLICATION

A smooth, strong, mini-crepe paper masking tape suitable for most paint masking applications. Designed for industrial use where a good paint line is desired and drying conditions range from air dry to an oven bake.

## CONSTRUCTION

Total Thickness	7.5 mils (w/o liner)
Adhesive Type	Natural/synthetic rubber blend
Carrier Type	A smooth crepe paper treated with a heat and solvent resistant saturant
Color	Tan

## SPECIFICATIONS

Temperature Range (°F)	325 (for one hour)
Tensile Strength (lbs/inch)	27
Elongation (%)	10
Peel Adhesion (oz/inch)	43

**Note:** Should not be subjected to outdoor exposure or prolonged sunlight. Tape may become difficult to remove.

C12 (2380) masking tape is designed specifically for use where high temperature cure is required. It is conformable, hugs curves, goes on quickly and easily, sticks at a touch and stays put. C12 (2380) produces an excellent finished paint line.

## SHELF LIFE

To obtain best performance, use this product within one year from the date of manufacture and store under normal conditions of 70°F (16 to 27°C) and 50% Relative Humidity in the original carton.

325°F intermittent rating. Contact an EPSI representative for recommendations on tapes for continuous or extended use. Many factors can affect the use and performance of a product in a particular application. This product should be tested to determine the suitability for its intended use.



866-ASK-EPSI (866-275-3774)  
866-FAX-EPSI (866-329-3774)

**80**

Order online at  
[www.epsi.com](http://www.epsi.com)

**YOU ASK IT.  
WE MASK IT.®**





**3M 2380 Tape**

**C12 Tape Series**

PART NUMBER	WIDTH (IN)	WIDTH (IN)	LENGTH (YDS)	WIDTH (MM)	LENGTH (M)	CASE QTY
C12-00095	0.375	3/8	60	9.5	55	64
C12-00127	0.500	1/2	60	12.7	55	48
C12-00159	0.625	5/8	60	15.9	55	40
C12-00190	0.750	3/4	60	19.1	55	32
C12-00254	1.000	1	60	25.4	55	24
C12-00381	1.500	1 1/2	60	38.1	55	16
C12-00508	2.000	2	60	50.8	55	12
C12-00762	3.000	3	60	76.2	55	8
C12-01016	4.000	4	60	101.6	55	8

Current pricing and additional sizes available at [www.epsi.com](http://www.epsi.com)



866-ASK-EPSI (866-275-3774)  
866-FAX-EPSI (866-329-3774)

81

Order online at [www.epsi.com](http://www.epsi.com)



# V14 Vinyl Electroplating Tape



**170°F (75°C)**



- **Maximum Temperature: 170°F**
- **Excellent Resistance to Electroplating Chemicals**
- **Abrasive Resistant**
- **Meets Federal Specification HH-T-0025 (GSA-FSS)**

## PRODUCT DESCRIPTION

V14 (470) is a 7.1 mil self-wound conformable colored vinyl backing with a rubber adhesive.

## TYPICAL APPLICATION

Masking during many electroplating operations, including both flat strip and overlapping masks. Wrapping, patching, coated racks and masking many irregular surfaces.

## CONSTRUCTION

Total Thickness	7.1 mils (w/o liner)
Adhesive Thickness	0.8 mils
Carrier Thickness	6.3 mils
Adhesive Type	Rubber
Carrier Type	Pigmented vinyl plastic
Color	Tan

## SPECIFICATIONS

Temperature Range (°F)	170
Tensile Strength (lbs/inch)	20
Elongation (%)	180
Peel Adhesion (oz/inch)	26
Government Specifications:	Can be qualified to meet federal Specification HH-T-0025 (GSA-FSS)

**Note:** While V14 (470) resists most solvents, avoid ketones, chlorinated hydrocarbons, and esters, found in thinners, degreasers, paint strippers, etc., which may cause the backing to swell or curl. Prolonged exposure to elevated temperatures and hot caustics may cause weakening of the adhesive bond.

**Authorized 3M Converter**

**3M 470 Tape**

**V14 Tape Series**

PART NUMBER	WIDTH (IN)	WIDTH (IN)	LENGTH (YDS)	WIDTH (MM)	LENGTH (M)	CASE QTY
V14-00254	1.000	1	36	25.4	32.9	24
V14-00381	1.500	1 1/2	36	38.1	32.9	16
V14-00508	2.000	2	36	50.8	32.9	12

■ **Current pricing and additional sizes available at [www.epsi.com](http://www.epsi.com)**

170°F intermittent rating. Contact an EPSI representative for recommendations on tapes for continuous or extended use. Many factors can affect the use and performance of a product in a particular application. This product should be tested to determine the suitability for its intended use.



866-ASK-EPSI (866-275-3774)  
866-FAX-EPSI (866-329-3774)

**82**

Order online at [www.epsi.com](http://www.epsi.com)



# P14 Lead Foil Tape



225°F (110°C)



- Electrically Conductive
- Malleable and Conforms to Surfaces
- Good Chemical Resistance
- Minimizes Undercutting for Straighter Lines

## PRODUCT DESCRIPTION

P14 (421) has a 5 mil nominal lead foil backing with a rubber adhesive, which is well suited as a maskant in electroplating and as a moisture and radiation barrier in certain applications. Additional applications include Radiation Barrier; Moisture Barrier; Chemical Milling; X-Ray Plate Masking.

## CONSTRUCTION

Total Thickness 6.8 mils (w/o liner)  
 Adhesive Thickness 2.1 mils  
 Carrier Thickness 4.7 mils  
 Adhesive Type Rubber (green)  
 Carrier Type Lead foil

## SPECIFICATIONS

Temperature Range (°F) -60 to 225  
 Tensile Strength (lbs/inch) 20  
 Elongation (%) 12  
 Peel Adhesion (oz/inch) 45  
 Moisture Vapor 0.1g H<sub>2</sub>O/100sq. In./24hrs  
 Government Specifications Can be certified to Fed. Specs. H-T29A

**Note:** Wear protective gloves and/or wash hands after working with tape. Lead will slowly leach into water when submerged. Leaching will accelerate as acidity increases. This material when disposed of separately is classified as RCRA hazardous waste. Please consult applicable Federal, State and Local regulations for proper disposal.

## 3M 421 Tape

## P14 Tape Series

PART NUMBER	WIDTH (IN)	WIDTH (IN)	LENGTH (YDS)	CASE QTY
P14-00127	0.500	1/2	36	72
P14-00190	0.750	3/4	36	48
P14-00254	1.000	1	36	36
P14-00381	1.500	1 1/2	36	24
P14-00508	2.000	2	36	24
P14-00762	3.000	3	36	16
P14-01016	4.000	4	36	12

225°F intermittent rating. Contact an EPSI representative for recommendations on tapes for continuous or extended use. Many factors can affect the use and performance of a product in a particular application. This product should be tested to determine the suitability for its intended use.



866-ASK-EPSI (866-275-3774)  
 866-FAX-EPSI (866-329-3774)

83

Order online at  
[www.epsi.com](http://www.epsi.com)



# HV V-Hooks



- V-Hook Geometry is Extremely Stable Under Loads (as compared to other hook geometries)
- Provides Superior Grounding (Multiple Grounding Contact Points)

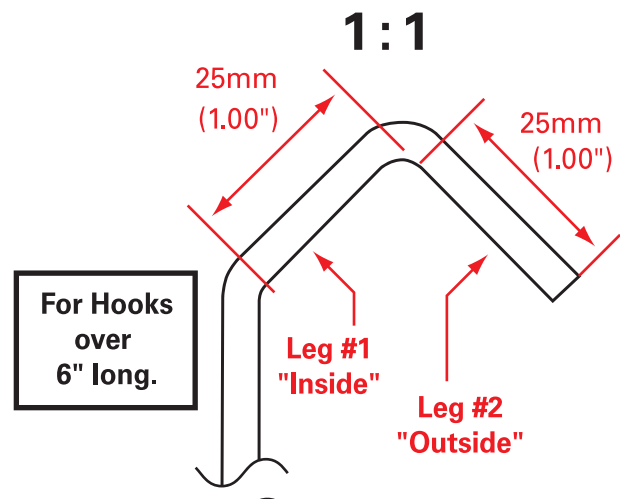
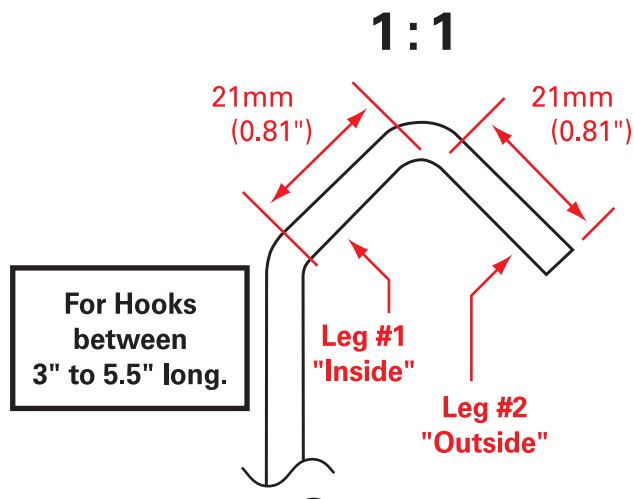

LOAD TABLE: V-Hooks			
Wire Diameter	0.25"	(6.0 mm)	*
	0.18"	(4.5 mm)	175 lbs
	0.12"	(3.0 mm)	80 lbs
	0.08"	(2.0 mm)	24 lbs
	0.06"	(1.5 mm)	12 lbs
			Safe Load Limits

**NOTE:** The recommended safe load limits were compiled under static load conditions in a laboratory fully accredited by the American Association for Laboratory Accreditation, conforming to ISO Guide 25. Although all load limits incorporate a safety factor, many factors will affect the actual dynamic load capacity of a hook. Such factors include sudden change in line speed, vibration in the conveyor, or in the case of suspension from two hooks, a shift in the center of gravity caused by an incline or stretching along curves in the conveyor. This product should be tested to determine the suitability for its intended use.

\* Please call your EPSI representative for further details.



866-ASK-EPSI (866-275-3774)  
866-FAX-EPSI (866-329-3774)

Order online at  
[www.epsi.com](http://www.epsi.com)







# HV90 V-Hooks

## 90° Bend



- V-Hook Geometry is Extremely Stable Under Loads (as compared to other hook geometries)
- 90° Bend Allows for Specific Hanging Orientation

Explanation of new Hook product numbers:  
(ie; HV90 15045-2525)

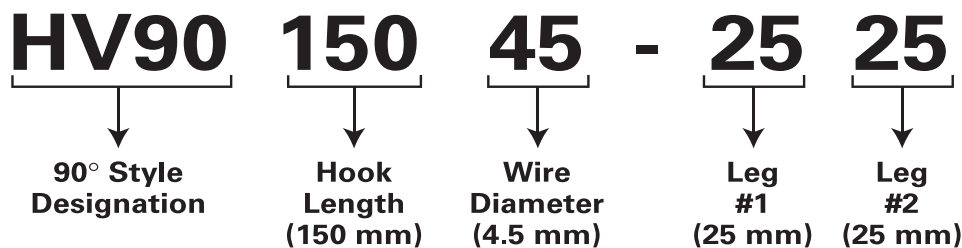

LOAD TABLE: V-Hooks			
Wire Diameter	0.25"	(6.0 mm)	*
	0.18"	(4.5 mm)	175 lbs
	0.12"	(3.0 mm)	80 lbs
	0.08"	(2.0 mm)	24 lbs
	0.06"	(1.5 mm)	12 lbs
			Safe Load Limits

**NOTE:** The recommended safe load limits were compiled under static load conditions in a laboratory fully accredited by the American Association for Laboratory Accreditation, conforming to ISO Guide 25. Although all load limits incorporate a safety factor, many factors will affect the actual dynamic load capacity of a hook. Such factors include sudden change in line speed, vibration in the conveyor, or in the case of suspension from two hooks, a shift in the center of gravity caused by an incline or stretching along curves in the conveyor. This product should be tested to determine the suitability for its intended use.

\* Please call your EPSI representative for further details.



866-ASK-EPSI (866-275-3774)  
866-FAX-EPSI (866-329-3774)

86

Order online at  
[www.epsi.com](http://www.epsi.com)



# HV-90 SERIES

PART NUMBER	OVERALL LENGTH	STANDARD (IN.)			METRIC (MM)			BOX QTY	
		WIRE DIA	LEG 1	LEG 2	OVERALL LENGTH	WIRE DIA	LEG 1		LEG 2
HV90 07515-2121	3	0.06	0.81	0.81	75	1.5	21	21	2500
HV90 10015-2121	4	0.06	0.81	0.81	100	1.5	21	21	2500
HV90 15015-2525	6	0.06	1.00	1.00	150	1.5	25	25	2500
HV90 07520-2121	3	0.08	0.81	0.81	75	2.0	21	21	2500
HV90 10020-2121	4	0.08	0.81	0.81	100	2.0	21	21	2500
HV90 15020-2525	6	0.08	1.00	1.00	150	2.0	25	25	2500
HV90 20020-2525	8	0.08	1.00	1.00	200	2.0	25	25	2500
HV90 37520-2525	15	0.08	1.00	1.00	375	2.0	25	25	1000
HV90 45020-2525	18	0.08	1.00	1.00	450	2.0	25	25	1000
HV90 10030-2525	4	0.12	1.00	1.00	100	3.0	25	25	1000
HV90 15030-2525	6	0.12	1.00	1.00	150	3.0	25	25	1000
HV90 20030-2525	8	0.12	1.00	1.00	200	3.0	25	25	1000
HV90 25030-2525	10	0.12	1.00	1.00	250	3.0	25	25	1000
HV90 30030-2525	12	0.12	1.00	1.00	300	3.0	25	25	500
HV90 60030-2525	24	0.12	1.00	1.00	600	3.0	25	25	250
HV90 75030-2525	30	0.12	1.00	1.00	750	3.0	25	25	250
HV90 15045-2525	6	0.18	1.00	1.00	150	4.5	25	25	500
HV90 30045-2525	12	0.18	1.00	1.00	300	4.5	25	25	250
HV90 45045-2525	18	0.18	1.00	1.00	450	4.5	25	25	250
HV90 15060-2525	6	0.25	1.00	1.00	150	6.0	25	25	500
HV90 20060-2525	8	0.25	1.00	1.00	200	6.0	25	25	500
HV90 30060-2525	12	0.25	1.00	1.00	300	6.0	25	25	250

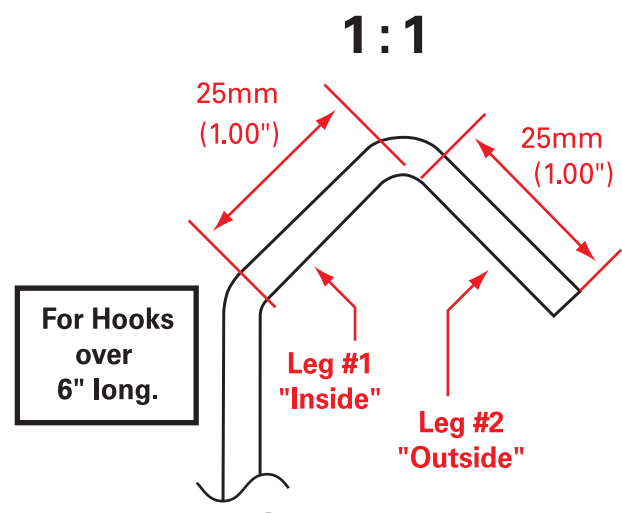
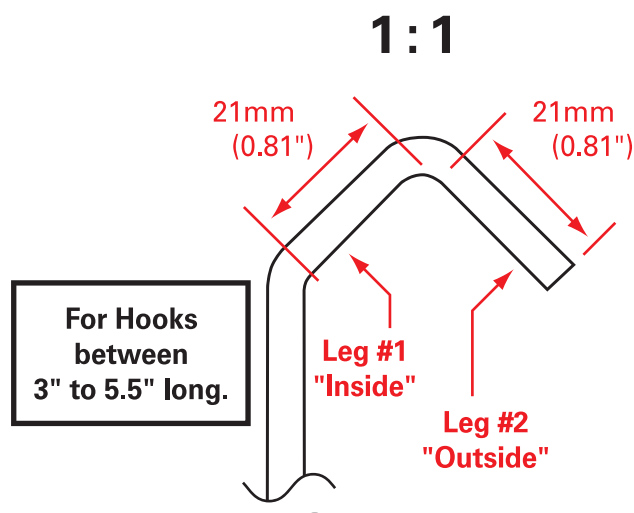

866-ASK-EPSI (866-275-3774)  
866-FAX-EPSI (866-329-3774)

Order online at  
[www.epsi.com](http://www.epsi.com)



# HS S-Hooks



- Can be Used in Combination to Daisy Chain Multiple Items Together
- Ideal for Wider Parts or Multiple Styles of Parts with Varying Thicknesses

**Explanation of new Hook product numbers:**  
(ie; HS 15045-38)

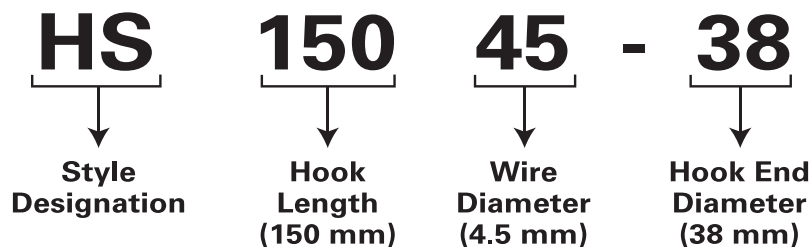

LOAD TABLE: S-Hooks			
Wire Diameter	0.25"	(6.0 mm)	*
	0.18"	(4.5 mm)	120 lbs
	0.12"	(3.0 mm)	56 lbs
	0.08"	(2.0 mm)	18 lbs
	0.06"	(1.5 mm)	9 lbs
			Safe Load Limits

**NOTE:** The recommended safe load limits were compiled under static load conditions in a laboratory fully accredited by the American Association for Laboratory Accreditation, conforming to ISO Guide 25. Although all load limits incorporate a safety factor, many factors will affect the actual dynamic load capacity of a hook. Such factors include sudden change in line speed, vibration in the conveyor, or in the case of suspension from two hooks, a shift in the center of gravity caused by an incline or stretching along curves in the conveyor. This product should be tested to determine the suitability for its intended use.

\* Please call your EPSI representative for further details.



866-ASK-EPSI (866-275-3774)  
866-FAX-EPSI (866-329-3774)



Order online at  
[www.epsi.com](http://www.epsi.com)





# HC C-Hooks

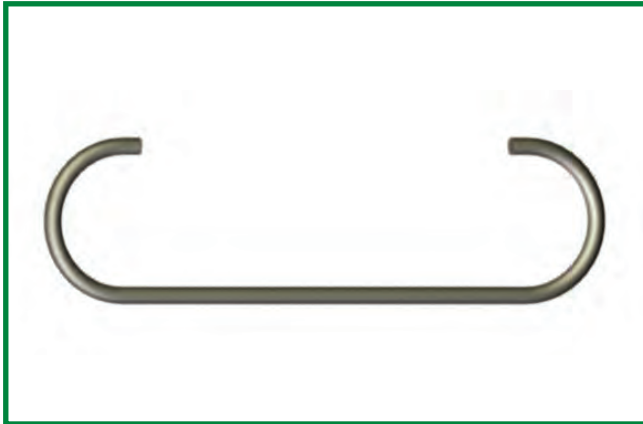

- Can be Used in Combination to Daisy Chain Multiple Items Together
- Ideal for Wider Parts or Multiple Styles of Parts with Varying Thicknesses

**Explanation of new Hook product numbers:**  
(ie; HC 15045-38)

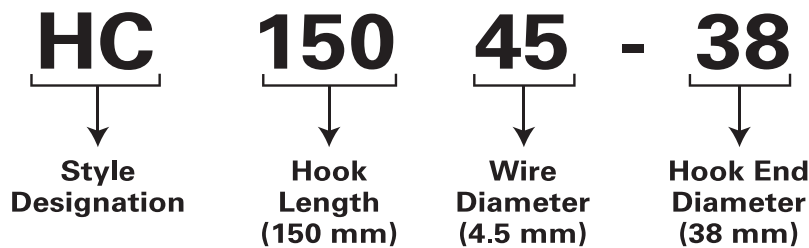

<b>LOAD TABLE: C-Hooks</b>			
<b>Wire Diameter</b>	0.25"	(6.0 mm)	*
	0.18"	(4.5 mm)	120 lbs
	0.12"	(3.0 mm)	56 lbs
	0.08"	(2.0 mm)	18 lbs
	0.06"	(1.5 mm)	9 lbs
			<b>Safe Load Limits</b>

**NOTE:** The recommended safe load limits were compiled under static load conditions in a laboratory fully accredited by the American Association for Laboratory Accreditation, conforming to ISO Guide 25. Although all load limits incorporate a safety factor, many factors will affect the actual dynamic load capacity of a hook. Such factors include sudden change in line speed, vibration in the conveyor, or in the case of suspension from two hooks, a shift in the center of gravity caused by an incline or stretching along curves in the conveyor. This product should be tested to determine the suitability for its intended use.

\* Please call your EPSI representative for further details.



866-ASK-EPSI (866-275-3774)  
866-FAX-EPSI (866-329-3774)

**90**

Order online at  
[www.epsi.com](http://www.epsi.com)







# HCV CV-Hooks



- Hybrid Hook Configuration
- Combines the Features of a V-Hook with the Ease of Use of a C-Hook
- Can be Used on Both Traditional and Round Stock Conveyor Systems
- Offer the Greatest Load Capacity with the Smallest Amount of Hook Marking

## Explanation of new Hook product numbers:

(ie; HCV 15045-32)

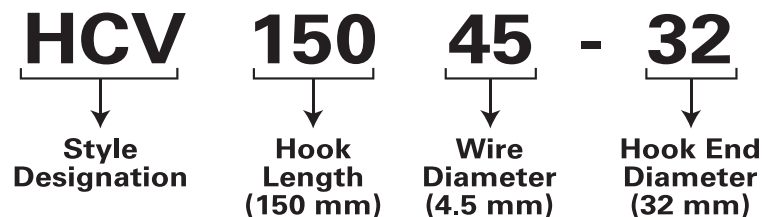

LOAD TABLE: CV-Hooks				
Wire Diameter	0.25"	(6.0 mm)		*
	0.18"	(4.5 mm)		120 lbs
	0.12"	(3.0 mm)		56 lbs
	0.08"	(2.0 mm)		18 lbs
	0.06"	(1.5 mm)		9 lbs
				Safe Load Limits

**NOTE:** The recommended safe load limits were compiled under static load conditions in a laboratory fully accredited by the American Association for Laboratory Accreditation, conforming to ISO Guide 25. Although all load limits incorporate a safety factor, many factors will affect the actual dynamic load capacity of a hook. Such factors include sudden change in line speed, vibration in the conveyor, or in the case of suspension from two hooks, a shift in the center of gravity caused by an incline or stretching along curves in the conveyor. This product should be tested to determine the suitability for its intended use.

\* Please call your EPSI representative for further details.

■ Current pricing and additional sizes available at [www.epsi.com](http://www.epsi.com)



866-ASK-EPSI (866-275-3774)  
866-FAX-EPSI (866-329-3774)

Order online at  
[www.epsi.com](http://www.epsi.com)



# HCV SERIES

PART NUMBER	LENGTH (in)	STANDARD WIRE DIA (in)	DIAMETER (in)	LENGTH (mm)	METRIC WIRE DIA (mm)	DIAMETER (mm)	BOX QTY
HCV 07515-25	3	0.06	1.00	75	1.5	25	2500
HCV 10015-32	4	0.06	1.25	100	1.5	32	2500
HCV 15015-38	6	0.06	1.50	150	1.5	38	2500
HCV 07520-25	3	0.08	1.00	75	2.0	25	2500
HCV 10020-32	4	0.08	1.25	100	2.0	32	2500
HCV 15020-38	6	0.08	1.50	150	2.0	38	2500
HCV 20020-38	8	0.08	1.50	200	2.0	38	2500
HCV 25020-38	10	0.08	1.50	250	2.0	38	2500
HCV 10030-32	4	0.12	1.25	100	3.0	32	1000
HCV 15030-38	6	0.12	1.50	150	3.0	38	1000
HCV 20030-38	8	0.12	1.50	200	3.0	38	1000
HCV 25030-38	10	0.12	1.50	250	3.0	38	1000
HCV 30030-38	12	0.12	1.50	300	3.0	38	500
HCV 37530-38	15	0.12	1.50	375	3.0	38	500
HCV 45030-38	18	0.12	1.50	450	3.0	38	500
HCV 15045-38	6	0.18	1.50	150	4.5	38	500
HCV 20045-38	8	0.18	1.50	200	4.5	38	500
HCV 25045-38	10	0.18	1.50	250	4.5	38	250
HCV 30045-38	12	0.18	1.50	300	4.5	38	250
HCV 45045-38	18	0.18	1.50	450	4.5	38	250
HCV 60045-38	24	0.18	1.50	600	4.5	38	100
HCV 30060-38	12	0.25	1.50	300	6.0	38	250

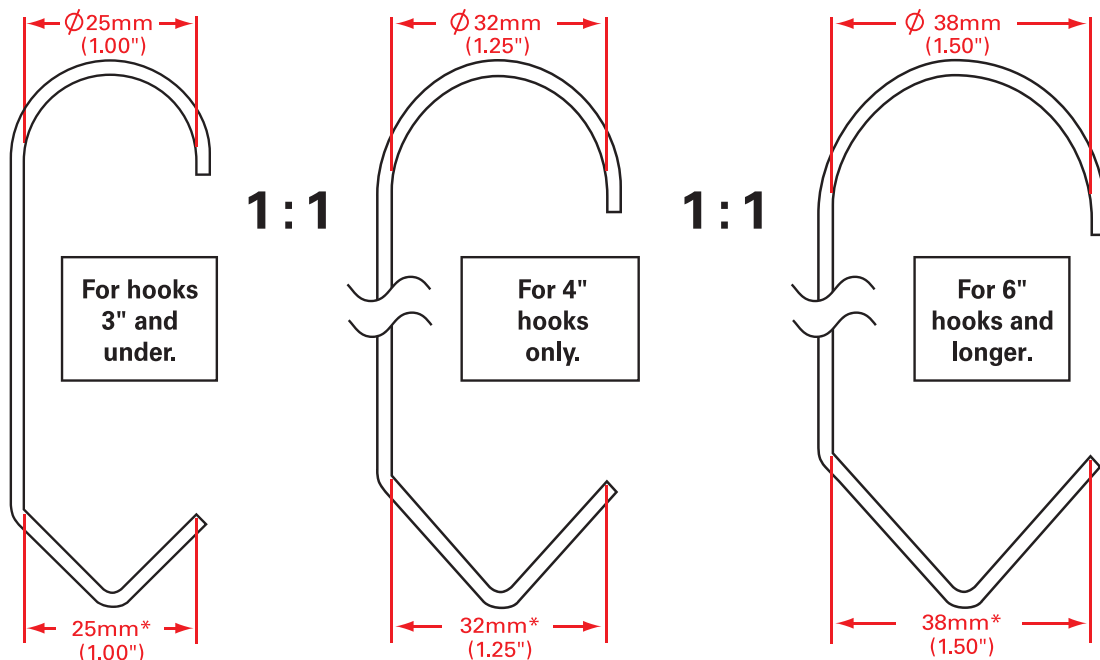

\* V-Hook end dimension is always consistent with diameter of C-Hook end.



866-ASK-EPSI (866-275-3774)  
866-FAX-EPSI (866-329-3774)

93

Order online at  
[www.epsi.com](http://www.epsi.com)



# HKVL V-Style Locking Hooks

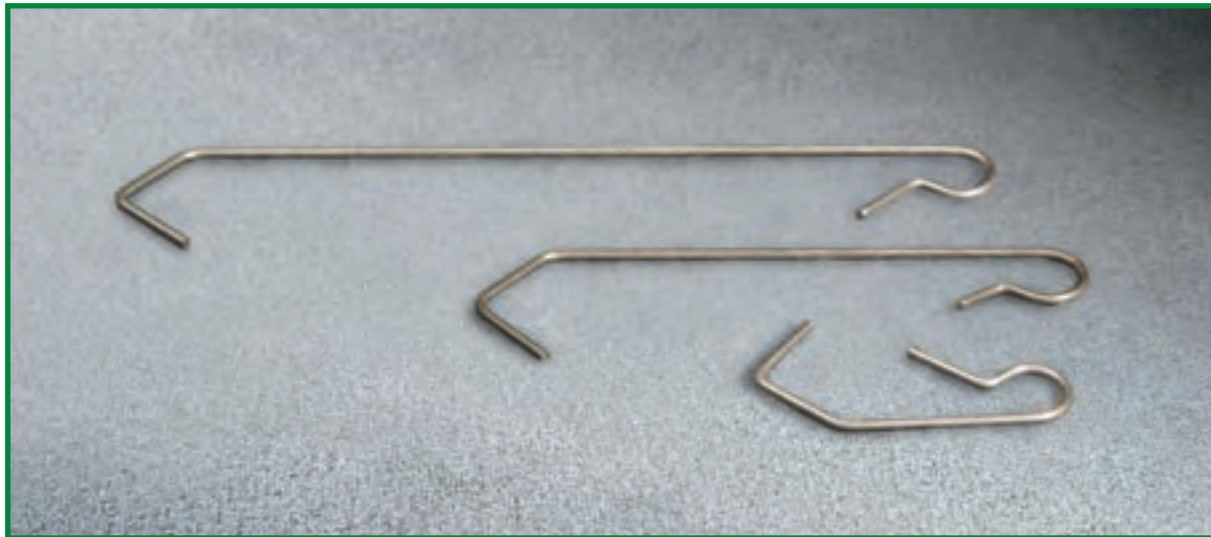

■ Designed to Fit Around Contact Points of Most Suspension Systems and Rods

■ Locking Eyelet Design Ensures that Hook will not Fall Off of Beams

## HKVL SERIES

PART NUMBER	STANDARD		METRIC		FITS ROD DIA (in)	BOX QTY
	LENGTH (in)	WIRE DIA (in)	LENGTH (mm)	WIRE DIA (mm)		
HKVL 375044-4	4	0.04	100	1.0	3/8	2500
HKVL 188060-2	2	0.06	50	1.5	3/16	2500
HKVL 188060-4	4	0.06	100	1.5	3/16	2500
HKVL 188060-6	6	0.06	150	1.5	3/16	2500
HKVL 250060-2	2	0.06	50	1.5	1/4	2500
HKVL 250060-4	4	0.06	100	1.5	1/4	2500
HKVL 250060-6	6	0.06	150	1.5	1/4	2500
HKVL 375060-4	4	0.06	100	1.5	3/8	2500
HKVL 375080-2	2	0.08	50	2.0	3/8	2500
HKVL 375080-4	4	0.08	100	2.0	3/8	2500
HKVL 375080-6	6	0.08	150	2.0	3/8	2500

■ Current pricing and additional sizes available at [www.epsi.com](http://www.epsi.com)



866-ASK-EPSI (866-275-3774)  
866-FAX-EPSI (866-329-3774)

94

Order online at  
[www.epsi.com](http://www.epsi.com)

**YOU ASK IT.  
WE MASK IT.®**

# CLAW

## Claw Hooks

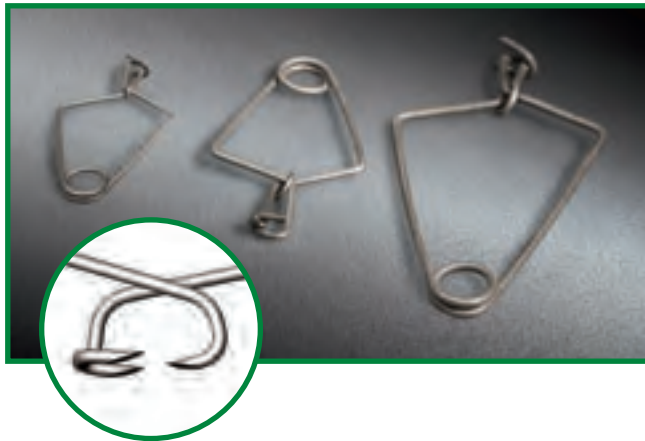

■ Our new claw hooks are designed to handle the most unusual of hanging situations. Their unique clamping action and strong contact points allow even the most unconventional of items to be hung.

- Available in Three Different Strengths:
  - Claw 200—(Light Duty to 5lbs)
  - Claw 300—(Medium Duty to 10lbs)
  - Claw 400—(Heavy Duty to 40lbs)

### CLAW SERIES

PART NUMBER	STANDARD		METRIC		NO. OF PRONGS	BOX QTY
	LENGTH (in)	WIRE DIA (in)	LENGTH (mm)	WIRE DIA (mm)		
CLAW 200	2.4	0.080	60	2.0	3	50
CLAW 300	4.8	0.120	120	3.0	3	50
CLAW 400	6.5	0.160	165	4.0	3	50

■ Current pricing and additional sizes available at [www.epsi.com](http://www.epsi.com)

# HKSC Sheet & Pipe Suspenders Hook



- Made of Cold Rolled Steel
- Reusable
- Suitable for Products that Have no Holes for Suspension
- Accepts Sheet Metal up to 4.0mm (.160") Thick
- Has Holes for Use with Standard Hooks for Easy Hanging

### HKSC 002040 SERIES

PART NUMBER	STANDARD PART THICKNESS (in)	METRIC PART THICKNESS (mm)	BOX QTY
HKSC 002040	0.080 - 0.157	2.0 - 4.0	50

■ Current pricing and additional sizes available at [www.epsi.com](http://www.epsi.com)



866-ASK-EPSI (866-275-3774)  
866-FAX-EPSI (866-329-3774)

95

Order online at [www.epsi.com](http://www.epsi.com)

**YOU ASK IT.  
WE MASK IT.®**



# HKRO Spring Tube Hooks

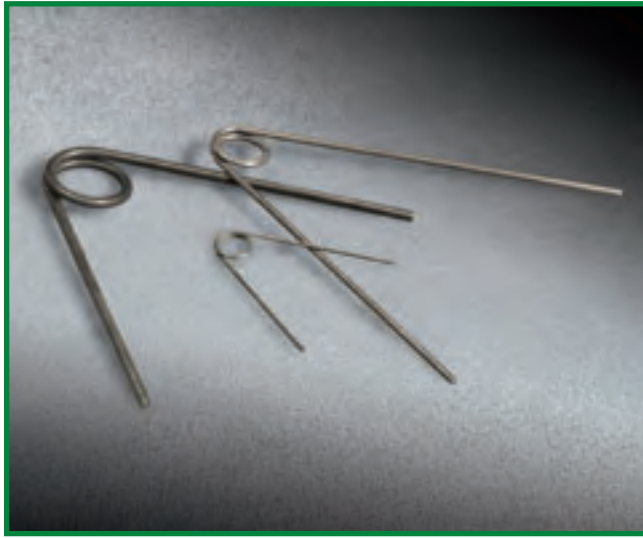

- Easy to Apply
- Allows for Hook Marks to be Hidden Inside of Holes and Other Non-Cosmetic Features
- Flexible Enough to Fit a Variety of Otherwise Difficult Applications
- Available in Three Different Strengths

◆ **CAUTION!** Please exercise caution when removing Spring Tube Hooks as they will expand quickly and with great force.



## HKRO SERIES

PART NUMBER	STANDARD LENGTH (in)	WIRE DIA (in)	METRIC LENGTH (mm)	WIRE DIA (mm)	BOX QTY
HKRO 100	1.770	0.040	45	1.0	250
HKRO 200	4.130	0.080	105	2.0	250
HKRO 300	4.250	0.120	108	3.0	250

■ Current pricing and additional sizes available at [www.epsi.com](http://www.epsi.com)



866-ASK-EPSI (866-275-3774)  
866-FAX-EPSI (866-329-3774)

96

Order online at [www.epsi.com](http://www.epsi.com)

**YOU ASK IT.  
WE MASK IT.®**

# SWIVEL Swivel Hooks

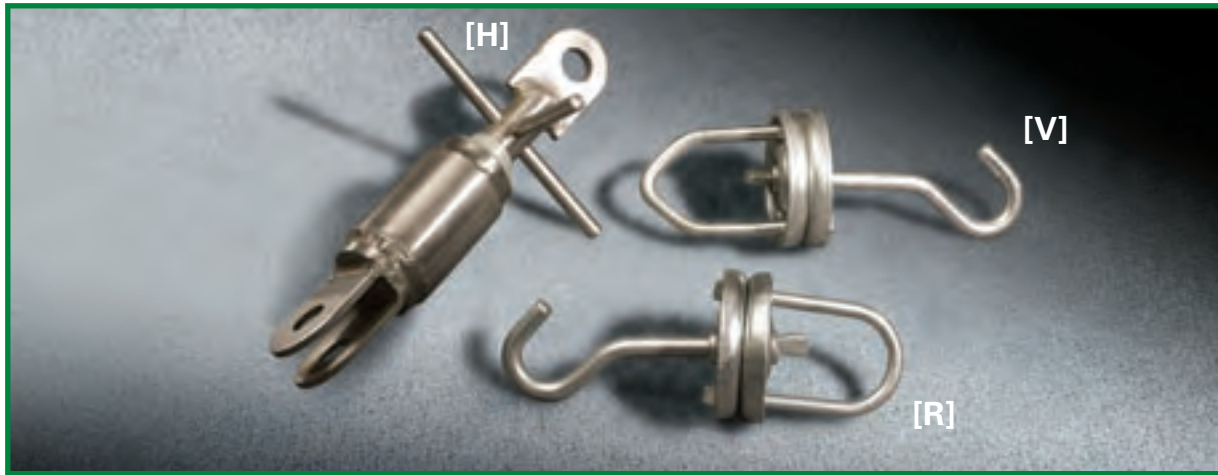

## [H] SERIES



- Stainless Steel Construction
- Holds up to 1,500 lbs
- Internal Mechanism is Completely Sealed
- Ball Bearings Ensure Smooth Rotation Even Under Loading
- Features Removable Pins for Adaptation to Indexing Conveyor Lines
- Designed to Rotate in Only One Direction

## [R] & [V] SERIES

- Cold Rolled Steel Construction
- Holds up to 250 lbs
- Ball Bearings Ensure Smooth Rotation Even Under Loading
- Feature a V-Shaped (Swivel-V) or a Radial (Swivel-R) Hanging Point
- Available in Cold-Rolled

### [R] SERIES



### [V] SERIES



## [H], [R] & [V] SERIES

PART NUMBER	STANDARD LOAD CAPACITY (LBS)	METRIC LOAD CAPACITY (Kg)	ROTATION	BOX QTY
SWIVEL (H)	1500	680	45 degree increments	1
SWIVEL (R)	250	110	Infinite	2
SWIVEL (V)	250	110	Infinite	2

■ Current pricing and additional sizes available at [www.epsi.com](http://www.epsi.com)



866-ASK-EPSI (866-275-3774)  
866-FAX-EPSI (866-329-3774)

97

Order online at  
[www.epsi.com](http://www.epsi.com)

**YOU ASK IT.  
WE MASK IT.®**

# ST Silicone Tubing

600°F (315°C)



- Fits Over Threaded Studs, Dowels, Pins and Tubing
- Conforms to Irregular Geometries

- Cut to Size
- Sizes Range from 0.040" ID to 2.000" ID

## PRODUCT DESCRIPTION

Our Silicone Tubing (ST) product line is ideal for masking off irregular geometries, long protrusions or as a substitute for short runs. The versatile nature of the tubing allows it to fit over extrusions, threaded studs, PEMS and dowels, as well as be used as a plug for tapped holes, irregular contours and threaded holes.

Our high temperature silicone is specially formulated to ensure reusability and economy during masking.

## TYPICAL INDUSTRY USES

Powder Coating, E-Coating, Plating and Anodizing

## TYPICAL APPLICATIONS

Used as a sleeve over threaded studs, dowels, and protrusions.  
Used as a flexible mask for round channels and cut outs.

## HELPFUL HINTS

- When sizing parts as a sleeve, the ID of the ST Tubing should be approximately equal to the stud diameter.
- To ensure easy removal, cut the tube length at least 1/2" longer than masking length of the stud. This is especially important if the tube ID is smaller than the stud diameter by more than 2%.
- When sizing parts as a plug, the OD should be at least 7% larger than the hole diameter.
- Due to the low tear resistance of silicone; do not use pliers or other sharp tools for removal.
- Can be used in conjunction with a standard cap to create a long, non-hollow cap.
- Use with EPSI's TUBE CUTTER for a clean, straight cut.



866-ASK-EPSI (866-275-3774)  
866-FAX-EPSI (866-329-3774)

98

Order online at  
[www.epsi.com](http://www.epsi.com)

**YOU ASK IT.  
WE MASK IT.®**

## ST SERIES

PART NUMBER	INNER DIAMETER (IN)	OUTER DIAMETER (IN)	INNER DIAMETER (MM)	OUTER DIAMETER (MM)	ROLL LENGTH (FT)
ST 0109	0.109	0.234	2.8	5.9	100
ST 0125	0.125	0.250	3.2	6.4	100
ST 0140	0.140	0.265	3.6	6.7	100
ST 0156	0.156	0.281	4.0	7.1	100
ST 0187	0.187	0.312	4.7	7.9	100
ST 0203	0.203	0.328	5.2	8.3	100
ST 0218	0.218	0.343	5.5	8.7	100
ST 0234	0.234	0.359	5.9	9.1	100
ST 0250	0.250	0.375	6.4	9.5	100
ST 0281	0.281	0.406	7.1	10.3	50
ST 0312	0.312	0.437	7.9	11.1	50
ST 0343	0.343	0.468	8.7	11.9	50
ST 0375	0.375	0.500	9.5	12.7	50
ST 0406	0.406	0.531	10.3	13.5	50
ST 0437	0.437	0.562	11.1	14.3	50
ST 0500	0.500	0.625	12.7	15.9	50
ST 0625	0.625	0.750	15.9	19.1	50
ST 0750	0.750	0.875	19.1	22.2	50
ST 0875	0.875	1.000	22.2	25.4	50
ST 1000	1.000	1.125	25.4	28.6	50
ST 1125	1.125	1.250	28.6	31.8	25
ST 1250	1.250	1.375	31.8	34.9	25
ST 1375	1.375	1.500	34.9	38.1	25
ST 1500	1.500	1.625	38.1	41.3	25
ST 1625	1.625	1.750	41.3	44.5	25
ST 1750	1.750	1.875	44.5	47.6	25
ST 1875	1.875	2.000	47.6	50.8	25
ST 2000	2.000	2.125	50.8	54.0	25

■ Current pricing and additional sizes available at [www.epsi.com](http://www.epsi.com)



866-ASK-EPSI (866-275-3774)  
866-FAX-EPSI (866-329-3774)

99

Order online at  
[www.epsi.com](http://www.epsi.com)



# CRDF Silicone Foam Cord

600°F (315°C)

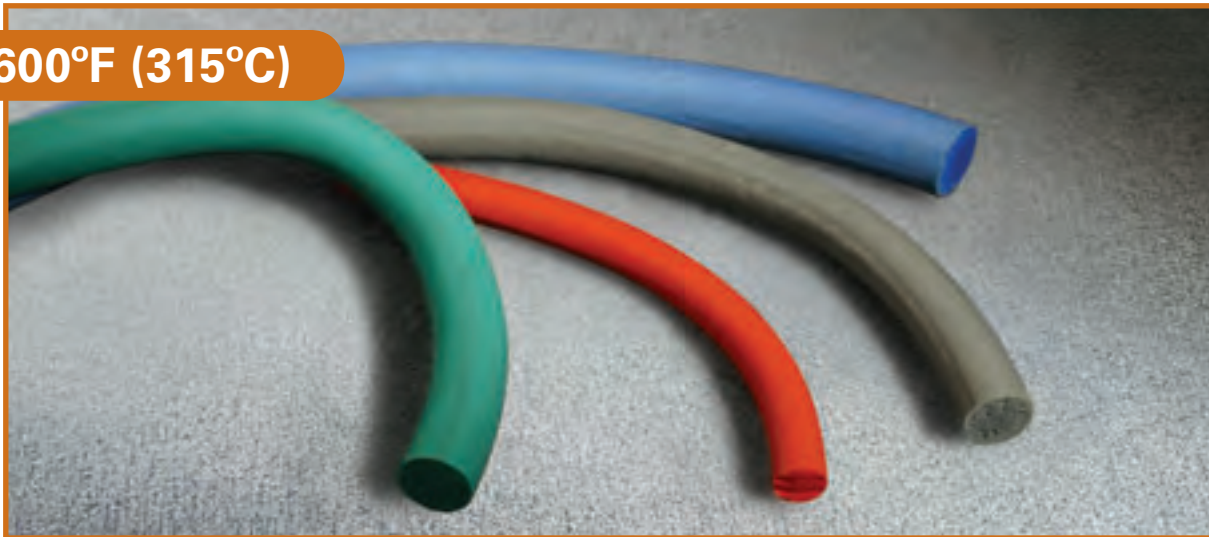

■ Compresses to Seal Off Slots and Through Holes

■ Conforms to Irregularly Shaped Openings

■ Cut to Size

■ Color Coded for Easy Identification

## PRODUCT DESCRIPTION

Our Solid Silicone Foam Cord (CRDF) product line is a great solution when looking for a compressible part to fit into a threaded or non-threaded opening. The solid silicone foam cord is so flexible that it can often be used to plug irregularly shaped openings. CRDF Cord is a closed-cell foam structure and will not absorb liquid.

## TYPICAL INDUSTRY USES

Powder Coating, E-Coating, Plating and Anodizing

## TYPICAL APPLICATIONS

Used to create a liquid tight seal in threaded and non-threaded slots, grooves, and through holes.

## HELPFUL HINTS

- Elongate the cord during application to make insertion easy. Cord will return back to original shape when released and create a liquid tight seal.
- To ensure a liquid tight seal, pick a product whose outer diameter (OD) dimension is at least 3-10% larger than the hole or groove that is being masked.



866-ASK-EPSI (866-275-3774)  
866-FAX-EPSI (866-329-3774)

100

Order online at  
[www.epsi.com](http://www.epsi.com)

**YOU ASK IT.  
WE MASK IT.®**



## CRDF SERIES

PART NUMBER	COLOR	DIAMETER (IN)	DIAMETER (IN)	DIAMETER (MM)	ROLL LENGTH (FT)
CRDF 0062-G	GREEN	0.062	1/16	1.6	50
CRDF 0125-B	BLACK	0.125	1/8	3.2	50
CRDF 0187-R	RED	0.187	3/16	4.7	50
CRDF 0250-Y	GRAY	0.250	1/4	6.4	50
CRDF 0312-U	BLUE	0.312	5/16	7.9	50
CRDF 0500-O	ORANGE	0.500	1/2	12.7	25
CRDF 0625-Y	GRAY	0.625	5/8	15.9	25
CRDF 0750-R	RED	0.750	3/4	19.1	25
CRDF 0875-Y	GRAY	0.875	7/8	22.2	25
CRDF 1000-U	BLUE	1.000	1	25.4	25

# CRDS Solid Silicone Cord

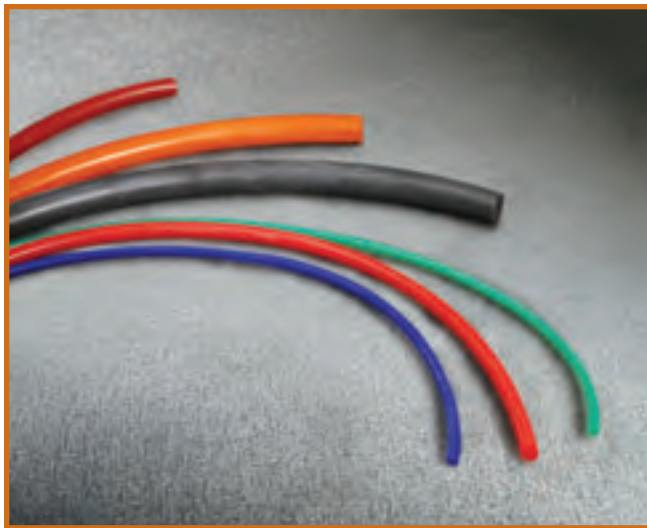

## PRODUCT DESCRIPTION

Our Solid Silicone Cord (CRDS) product line is a great solution for sealing off exposed semi-circular cut-outs on machined parts. It can also be used to plug threaded and non-threaded holes. Versatile and easy to cut to length, Solid Silicone Cord is a great product to have for short runs.



■ Plug Exposed Channels or Grooves on Machined Parts

■ Used to Plug Threaded and Non-Threaded Holes

■ Cut to Size

■ Color Coded for Easy Identification

## CRDS SERIES

PART NUMBER	COLOR	DIAMETER (IN)	DIAMETER (IN)	DIAMETER (MM)	ROLL LENGTH (FT)
CRDS 0063-R	RED	0.063	1/16	1.6	100
CRDS 0125-O	ORANGE	0.125	1/8	3.2	100
CRDS 0188-P	PURPLE	0.188	3/16	4.8	100
CRDS 0250-N	PINK	0.250	1/4	6.4	100
CRDS 0375-R	RED	0.375	3/8	9.5	50
CRDS 0500-P	PURPLE	0.500	1/2	12.7	50



866-ASK-EPSI (866-275-3774)  
866-FAX-EPSI (866-329-3774)

101

Order online at  
[www.epsi.com](http://www.epsi.com)

**YOU ASK IT.  
WE MASK IT.®**

# FSTS Flexible Star Tubing

600°F (315°C)



- Fits Over Threaded Studs, Dowels, Pins and Tube Stock
- Each Size Fits Multiple Diameters
- Low Friction for Easy Placement and Removal
- Flexible Enough to Conform to Irregular Geometries
- Cut to Size
- Sizes Range from 0.200" ID to 2.000" ID
- Color Coded for Easy Identification

## PRODUCT DESCRIPTION

Our Flexible Star Tubing (FSTS) product line is ideal for masking off irregular geometries, long protrusions or as a fill-in for small runs of parts. Our high temperature silicone is specially formulated to ensure reusability and economy during masking.

## TYPICAL INDUSTRY USES

Powder Coating, E-Coating, Plating and Anodizing



## FSTS SERIES

PART NUMBER	COLOR	MINOR ID (IN)	MAJOR ID (IN)	APPLICATION RANGE (IN)	MINOR ID (MM)	MAJOR ID (MM)	APPLICATION RANGE (MM)	ROLL LENGTH (FT)
FSTS 0200-W	WHITE	0.200	0.250	0.200 - 0.250	5.1	6.4	5.1 - 6.4	100
FSTS 0300-F	RUSTY	0.300	0.375	0.300 - 0.375	7.6	9.5	7.6 - 9.5	100
FSTS 0400-L	YELLOW	0.400	0.500	0.400 - 0.500	10.2	12.7	10.2 - 12.7	100
FSTS 0500-P	PURPLE	0.500	0.625	0.500 - 0.625	12.7	15.9	12.7 - 15.9	100
FSTS 0625-F	RUSTY	0.625	0.750	0.625 - 0.750	15.9	19.1	15.9 - 19.1	50
FSTS 0725-U	BLUE	0.725	0.875	0.725 - 0.875	18.4	22.2	18.4 - 22.2	50
FSTS 0850-W	WHITE	0.850	1.000	0.850 - 1.000	21.6	25.4	21.6 - 25.4	50
FSTS 1000-C	CLEAR	1.000	1.250	1.000 - 1.250	25.4	31.8	25.4 - 31.8	25
FSTS 1250-P	PURPLE	1.250	1.500	1.250 - 1.500	31.8	38.1	31.8 - 38.1	25
FSTS 1500-F	RUSTY	1.500	1.750	1.500 - 1.750	38.1	44.5	38.1 - 44.5	25
FSTS 1750-O	ORANGE	1.750	2.000	1.750 - 2.000	44.5	50.8	44.5 - 50.8	25

■ Current pricing and additional sizes available at [www.epsi.com](http://www.epsi.com)



866-ASK-EPSI (866-275-3774)  
866-FAX-EPSI (866-329-3774)

102

Order online at  
[www.epsi.com](http://www.epsi.com)

**YOU ASK IT.  
WE MASK IT.®**

# SHFS/SHRS Silicone Sheetting

600°F (315°C)



- Can be Die Cut to Almost any Shape
- Reusable Paint Mask
- Solid Rubber (SHRS) is Ideal for Gaskets in Automotive Sealing Application
- Foam Sheetting (SHFS) is Conformable and Light Weight

## PRODUCT DESCRIPTION

Our Silicone Foam (SHFS) and Solid Silicone Rubber (SHRS) sheetting product lines are ideal for applications such as gasketing, sound deadening and paint masking during powder coating. Various thicknesses are offered to cover a variety of applications.

## TYPICAL INDUSTRY USES

Powder Coating, E-Coating, Plating and Anodizing

## TYPICAL APPLICATIONS

Used as a gasket, washer, pads, strips and seals. Used as sound deadening in automotive applications. Mask surfaces during powder coating.

## HELPFUL HINTS

- Silicone foam is more conformable and lighter in weight than solid silicone rubber.
- Silicone foam's fabric-like top film is extremely durable and resists powder build-up.
- Silicone rubber has a smooth surface where as silicone foam has a textured surface.
- Saves labor time over traditional tape masking, and can be reused for additional cost savings.
- Foam sheetting is a closed-cell structure and will not absorb water.

**Can be die-cut to any shape. Both materials can be supplied with an acrylic adhesive system on one side for permanent applications; call for details.**

## SHFS SERIES

## SILICONE FOAM

PART NUMBER	THICKNESS (IN)	STANDARD THICKNESS (IN)	LEN X WIDTH (IN)	METRIC	
				THICKNESS (MM)	LEN X WIDTH (MM)
SHFS 0032	0.125	1/8	36 X 36	3.2	914 X 914
SHFS 0064	0.250	1/4	36 X 36	6.4	914 X 914
SHFS 0127	0.500	1/2	36 X 36	12.7	914 X 914

## SHRS SERIES

## SOLID SILICONE RUBBER

PART NUMBER	THICKNESS (IN)	STANDARD THICKNESS (IN)	LEN X WIDTH (IN)	METRIC	
				THICKNESS (MM)	LEN X WIDTH (MM)
SHRS 0016	0.063	1/16	36 X 36	1.6	914 X 914
SHRS 0024	0.094	3/32	36 X 36	2.4	914 X 914
SHRS 0032	0.125	1/8	36 X 36	3.2	914 X 914
SHRS 0048	0.188	3/16	36 X 36	4.8	914 X 914



866-ASK-EPSI (866-275-3774)  
866-FAX-EPSI (866-329-3774)

103

Order online at  
[www.epsi.com](http://www.epsi.com)

**YOU ASK IT.  
WE MASK IT.®**

# SHMS Silicone Magnetic Sheetting

500°F (260°C)



- Hi-Temperature Silicone Magnets Exclusively from EPSI
- Used in Die Cut Form to Match and Protect Specific Contours on Sheet Metal and Formed Metal Parts

- Magnets are Reusable
- Eliminates the Need for Masking Die-Cuts with Adhesives

## PRODUCT DESCRIPTION

Our Silicone Magnetic Sheetting (SHMS) product line can replace the need for polyester tape in many masking applications, and through reusability and ease of application can lower overall masking costs.

It is an attractive alternative to traditional tape masking, as well as the use of vinyl magnets which need to be removed prior to curing. Silicone Magnetic Sheetting is easy to apply, leaves no residue on the surface and is reusable.

## TYPICAL INDUSTRY USES

Powder Coating and Wet Spray

## TYPICAL APPLICATIONS

When used in die cut profiles, Silicone Magnetic Sheetting is used to protect flat surfaces on ferrous metal objects.

## HELPFUL HINTS

- Silicone magnetic sheetting is only magnetic on one surface.
- For best results, silicone magnetic sheetting should be applied to clean, flat, ferrous metal surfaces.
- Silicone Magnetic Sheetting can be purchased either in raw sheet form or in die cut shapes, depending on the application.

Can be die-cut to any shape. Call for details.

## SHMS SERIES

PART NUMBER	STANDARD		METRIC	
	LEN X WIDTH (IN)	THICKNESS (IN)	LEN X WIDTH (MM)	THICKNESS (MM)
SHMS 0010	40 X 40	0.040	1000 X 1000	1.0

- Current pricing and additional sizes available at [www.epsi.com](http://www.epsi.com)



866-ASK-EPSI (866-275-3774)  
866-FAX-EPSI (866-329-3774)

104

Order online at [www.epsi.com](http://www.epsi.com)





# SHMV Vinyl Magnetic Sheeting

176°F (80°C)

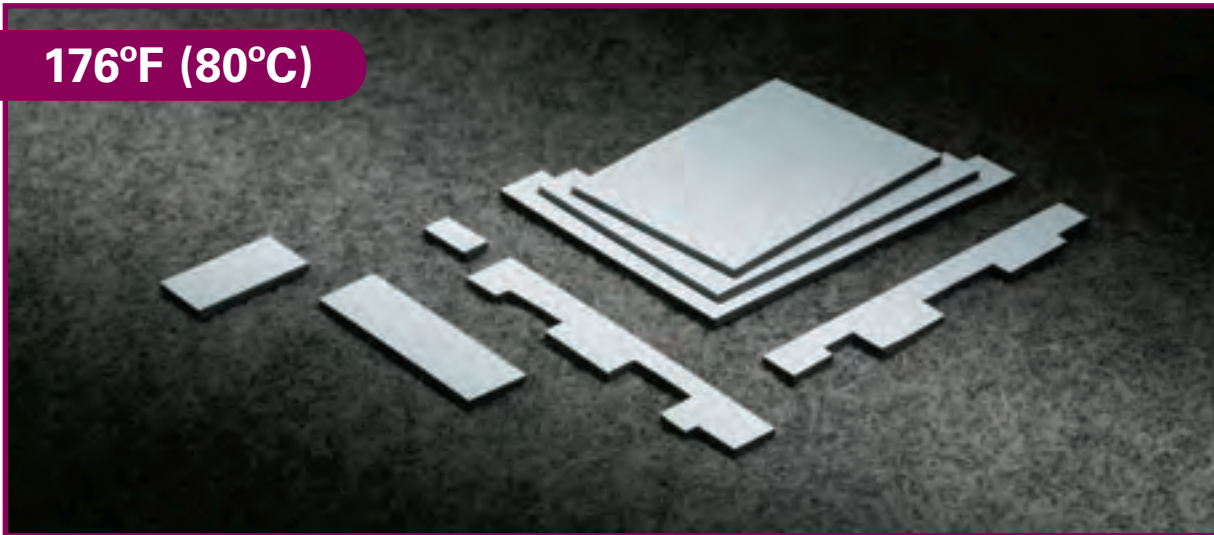

- Used in Die Cut Form to Match and Protect Specific Contours on Sheet Metal and Formed Metal Parts
- Eliminates the Need for Masking Tapes with Traditional Adhesives

- Reusable Protection for Low Temperature Finishing Needs
- Most Economical of the Magnetic Sheeting Choices

## PRODUCT DESCRIPTION

Our Vinyl Magnetic Sheeting (SHMV) product line is an attractive alternative to traditional tape masking of flat surfaces. Vinyl Magnetic Sheeting is easy to apply, leaves no residue on the surface and is reusable. Vinyl Magnetic Sheeting can replace the need for crepe tape in many masking applications.

## TYPICAL INDUSTRY USES

Powder Coating, Wet Spray, Plating, and Anodizing

## TYPICAL APPLICATIONS

When used in die cut profiles, Vinyl Magnetic Sheeting is used to protect flat surfaces on sheet metal. Vinyl Magnetic Sheeting can replace the need for crepe tape in many masking applications, and through reusability and ease of application can lower overall masking costs.

## HELPFUL HINTS

- Vinyl exhibits good chemical resistance properties and holds up well in plating and anodizing processes.
- For best results, vinyl magnetic sheeting should be applied to clean, flat, ferrous metal surfaces.
- Vinyl magnetic sheeting can be purchased either in raw sheet form or in die cut shapes, depending on application.
- Vinyl magnet is not as flexible as silicone magnet and should only be applied to flat surfaces.

Can be die-cut to any shape. Call for details.

## SHMV SERIES

PART NUMBER	STANDARD		METRIC	
	LEN X WIDTH (IN)	THICKNESS (IN)	LEN X WIDTH (MM)	THICKNESS (MM)
SHMV 0015-SHEET	24 X 60	0.060	610 X 1,524	1.5



866-ASK-EPSI (866-275-3774)  
866-FAX-EPSI (866-329-3774)

105

Order online at  
[www.epsi.com](http://www.epsi.com)





# TC-250 Oven Cleaning Film

450°F (235°C)



- Keep Your Oven Clean and Dust Free
- Continuous Oven Cleaning without Shut-Down
- Works Every Time it Passes Through Your Oven
- Changes Color When Film is Almost "Full"
- Keep Parts Running During Color Changes

## TYPICAL INDUSTRY USES

Powder Coating



### TYPICAL APPLICATIONS

Used to remove air-borne free powder particles from oven.

### USES

Our Thermal Cast Oven Cleaning Film (TC-250) is a special heat sensitive film that develops a super-absorbent adhesive-like skin at elevated temperatures. Specially developed for use in curing and dry-off ovens to remove airborne dust and contaminants.

## PRODUCT DESCRIPTION

TC-250 is smooth and non-tacky at ambient temperatures, but starts to soften and become tacky at temperatures above 250°F (120°C). TC-250 will pass through ovens set as high as 450°F (235°C) with minimal sagging or hot flow of the film.

In its thermally activated condition, the softened film will cause dust or airborne particles that pass over its surface to adhere. By hanging sheets of TC-250 at regular intervals throughout the paint line, contaminants that would otherwise be picked up on the painted work surface, adhere permanently to the TC-250 film. The efficiency of the film decreases with increasing oxidation (observed by a darkening of the film). Experience has shown that coated panels are still effective after 200 or more passes through the curing ovens.

## TC-250 SERIES

PART NUMBER	STANDARD		METRIC	
	WIDTH (IN)	LENGTH (YDS)	WIDTH (MM)	LENGTH (M)
TC-250	12	33	300	30

## METHOD OF APPLICATION

TC-250 should be bonded to a clean dry metal panel which is capable of being placed in an oven, or hung from the conveyor system. A lightweight thin aluminum sheet is the preferred method for ease of handling and its thermal properties.

1. TC-250 is supplied in 2 parts: the TC-250 film (clear) and TC 250 liner (yellow).
2. Lay the cut-to-size film on the metal and place the matching liner over it.
3. TC-250 is first bonded to the substrate by applying pressure to the liner over the film. This is

best done if pressure is applied using a swipe device (squeegee).

4. Keeping the liner over the film, apply a heat gun or iron to the liner/film.
5. After allowing the bonded film to cool to room temperature, the liner should be removed.

**Note: If TC-250 is to be applied to BOTH sides of a metal panel, it is recommended to leave the liner intact until both sides are laminated.**



866-ASK-EPSI (866-275-3774)  
866-FAX-EPSI (866-329-3774)

106

Order online at  
[www.epsi.com](http://www.epsi.com)



# CAPS / PLUGS

## Starter Kits



KIT SC-1					See Page 9 for Details
SC 0070X1000	SC 0080X0750	SC 0093X0750	SC 0100X1000	SC 0109X0750	SC 0125X1000
SC 0140X1000	SC 0148X1000	SC 0156X1000	SC 0172X0500	SC 0172X1000	SC 0187X0500
SC 0187X1000	SC 0197X0500	SC 0218X1000	SC 0223X1000	SC 0234X1000	SC 0250X1000
KIT SC-2					See Page 9 for Details
SC 0281X1000	SC 0295X1000	SC 0312X1000	SC 0340X1000	SC 0355X1500	SC 0366X1500
SC 0375X1000	SC 0406X1000	SC 0437X1000	SC 0456X1500	SC 0500X1500	SC 0562X1500
SC 0600X1500	SC 0625X1500	SC 0687X1500	SC 0730X1500	SC 0875X1500	SC 0937X1500



KIT EC-1					See Page 17 for Details
EC 0040X0750	EC 0062X0750	EC 0100X1000	EC 0109X0750	EC 0125X1000	EC 0140X1000
EC 0148X1000	EC 0156X1000	EC 0172X1000	EC 0180X1000	EC 0187X1000	EC 0197X0500
EC 0218X1000	EC 0223X0500	EC 0223X1500	EC 0234X1000	EC 0234X1500	EC 0250X1000
KIT EC-2					See Page 17 for Details
EC 0295X0500	EC 0295X1000	EC 0312X1000	EC 0312X1500	EC 0340X1000	EC 0355X1500
EC 0375X1000	EC 0437X1000	EC 0456X1500	EC 0468X1000	EC 0480X1500	EC 0500X1500
EC 0535X1500	EC 0600X1500	EC 0625X1500	EC 0750X1500	EC 0812X1500	EC 0875X1500



KIT CONS/CONE					See Page 15 for Details
CONS 00613	CONS 00813	CONS 01017	CONS 01116	CONS 01419	CONS 01725
CONS 02028	CONS 02125	CONS 02231	CONE 00613	CONE 00813	CONE 01017
CONE 01116	CONE 01419	CONE 01725	CONE 02028	CONE 02125	CONE 02231



CONS CONE

KIT STS-1					See Page 20 for Details
STS 0062X0625	STS 0078X1000	STS 0100X1000	STS 0125X0625	STS 0187X0625	STS 0197X1100
STS 0200X0750	STS 0216X1500	STS 0250X0750	STS 0250X1000	STS 0276X0787	STS 0315X0787
STS 0343X0625	STS 0343X1000	STS 0375X0500	STS 0375X0750	STS 0393X0787	STS 0437X1000
KIT STS-2					See Page 20 for Details
STS 0472X0748	STS 0500X0813	STS 0500X1000	STS 0562X1125	STS 0563X1000	STS 0590X1000
STS 0625X0813	STS 0656X1000	STS 0687X1000	STS 0748X1000	STS 0787X1000	STS 0812X1000
STS 0938X1000	STS 1024X1000	STS 1063X1000	STS 1102X1000	STS 1220X1181	STS 1260X1000



866-ASK-EPSI (866-275-3774)  
866-FAX-EPSI (866-329-3774)

107

Order online at  
[www.epsi.com](http://www.epsi.com)

**YOU ASK IT.  
WE MASK IT.®**

# PLUGS



# Starter Kits



KIT BES						See Page 23 for Details
BES 0100X0625	BES 0125X0625	BES 0187X0750	BES 0200X0750	BES 0250X1000	BES 0343X1000	
BES 0375X0750	BES 0437X1000	BES 0472X0748	BES 0500X1000	BES 0563X1000	BES 0590X1000	
BES 0625X0813	BES 0748X1000	BES 0787X1000	BES 0938X1000	BES 1024X1000	BES 1063X1000	

KIT CRKR						See Page 26 for Details
CRKR 0189	CRKR 0248	CRKR 0311	CRKR 0374	CRKR 0437	CRKR 0500	
CRKR 0563	CRKR 0626	CRKR 0689	CRKR 0748	CRKR 0799	CRKR 0874	
CRKR 0874	CRKR 0937	CRKR 0937	CRKR 1000	CRKR 1000	CRKR 1000	

KIT FLPS						See Page 27 for Details
FLPS 00402-N	FLPS 00604-C	FLPS 00806-Y	FLPS 01008-F	FLPS 01210-U	FLPS 01412-C	
FLPS 01614-Y	FLPS 01816-F	FLPS 02018-U	FLPS 02018-U	FLPS 02220-C	FLPS 02220-C	
FLPS 02422-Y	FLPS 02422-Y	FLPS 02624-F	FLPS 02624-F	FLPS 02826-U	FLPS 02826-U	

KIT SPP-1						See Page 35 for Details
SPP 0073X0625	SPP 0091X1000	SPP 0093X0625	SPP 0109X1000	SPP 0118X1000	SPP 0125X0625	
SPP 0130X1000	SPP 0140X0625	SPP 0154X0625	SPP 0156X0625	SPP 0158X1000	SPP 0162X0625	
SPP 0175X1250	SPP 0187X0625	SPP 0190X1250	SPP 0197X1000	SPP 0218X1000	SPP 0225X1000	
KIT SPP-2						See Page 35 for Details
SPP 0236X1250	SPP 0257X1000	SPP 0275X0950	SPP 0281X1000	SPP 0312X1000	SPP 0332X1125	
SPP 0335X1000	SPP 0350X0900	SPP 0388X1000	SPP 0400X1000	SPP 0437X1250	SPP 0440X1000	
SPP 0445X1000	SPP 0468X1250	SPP 0500X1000	SPP 0530X1000	SPP 0612X1000	SPP 0640X1000	

KIT SOMS™						See Page 41 for Details
SOMS X2012-C	SOMS X3116-C	SOMS X4016-C	SOMS X4816-C	SOMS X5317-C	SOMS X4020-C	
SOMS X6020-C	SOMS X6024-C	SOMS X6924-C	SOMS X4032-C	SOMS X6032-C	SOMS X6032-C	
SOMS X6540-C	SOMS X6540-C	SOMS X7940-C	SOMS X7940-C	SOMS X7948-C	SOMS X7948-C	



866-ASK-EPSI (866-275-3774)  
866-FAX-EPSI (866-329-3774)

108

Order online at  
[www.epsi.com](http://www.epsi.com)

**YOU ASK IT.  
WE MASK IT.®**

# PLUGS

## Starter Kits





KIT EPP						See Page 44 for Details
EPP 0093X0625	EPP 0105X1000	EPP 0109X0625	EPP 0125X0625	EPP 0130X0625	EPP 0140X0625	
EPP 0156X0625	EPP 0162X0625	EPP 0187X0625	EPP 0218X1000	EPP 0225X1000	EPP 0257X1000	
EPP 0281X1000	EPP 0312X1000	EPP 0335X1000	EPP 0350X0900	EPP 0388X1000	EPP 0440X1000	

KIT TNM						See Page 43 for Details
TNM 0082	TNM 0100	TNM 0106	TNM 0120	TNM 0131	TNM 0156	
TNM 0171	TNM 0186	TNM 0212	TNM 0212	TNM 0270	TNM 0270	
TNM 0335	TNM 0335	TNM 0400	TNM 0400	TNM 0470	TNM 0470	

KIT FLPE						See Page 27 for Details
FLPE 00402	FLPE 00604	FLPE 00806	FLPE 01008	FLPE 01210	FLPE 01412	
FLPE 01614	FLPE 01816	FLPE 02018	FLPE 02018	FLPE 02220	FLPE 02220	
FLPE 02422	FLPE 02422	FLPE 02624	FLPE 02624	FLPE 02826	FLPE 02826	

KIT WP						See Page 30 for Details
WP130-250-140	WP130-250-200	WP140-250-180	WP155-250-238	WP130-312-155	WP155-312-238	
WP200-312-238	WP200-312-275	WP180-350-225	WP200-375-275	WP209-375-275	WP275-375-375	
WP130-500-375	WP155-500-390	WP275-500-375	WP375-500-455	WP390-500-455	WP140-625-250	

KIT BTM						See Page 34 for Details
BTM 0208	BTM 0218	BTM 0278	BTM 0283	BTM 0336	BTM 0336	
BTM 0358	BTM 0358	BTM 0392	BTM 0392	BTM 0426	BTM 0426	
BTM 0451	BTM 0451	BTM 0583	BTM 0583	BTM 0724	BTM 0724	

KIT WPP						See Page 38 for Details
WPP 0173-R	WPP 0217-U	WPP 0224-Y	WPP 0283-L	WPP 0331-O	WPP 0346-N	
WPP 0413-G	WPP 0413-G	WPP 0439-P	WPP 0439-P	WPP 0490-W	WPP 0490-W	
WPP 0518-Y	WPP 0518-Y	WPP 0545-F	WPP 0545-F	WPP 0580-R	WPP 0580-R	



866-ASK-EPSI (866-275-3774)  
866-FAX-EPSI (866-329-3774)

109

Order online at  
[www.epsi.com](http://www.epsi.com)

**YOU ASK IT.  
WE MASK IT.®**



# Powder Coating Filters

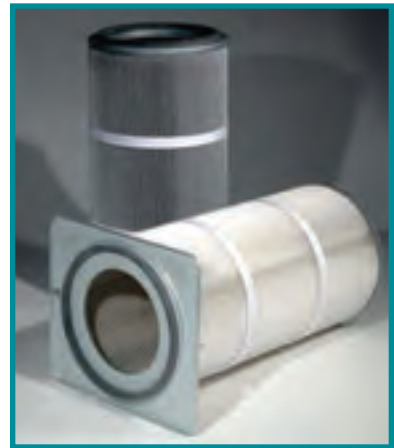
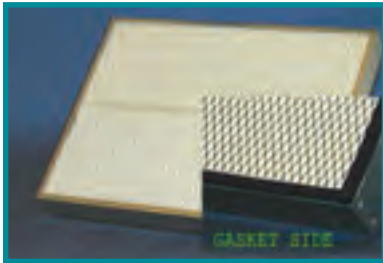

EPSI now offers pleated filters designed specifically for the powder coating industry.

Our filters are a high-quality alternative to the premium-priced brand-name elements from Gema®, GFS®, Torit®, Nordson®, Wagner®, Deimco®, and others.

We can meet any design requirements and manufacture filters using several different media types, depending on customer-specific application, including specialized media finishes such as:

**TX** (ePTFE membrane) for unsurpassed product release characteristics,

**ME** (aluminized anti-static surface) for excellent release of electronically charged powder or

**FR** (fire-retardant treatment) for applications where fire hazard is a concern.

Our standard media selection includes:

**SB** – 100% spun bond polyester, washable, excellent release characteristics (great choice for those powder coaters who reclaim their powder)

**QX** – A blend of spun bond and cellulose fibers, high efficiency media with excellent resistance to moisture (perfect for those powder coaters who spray to waste)

GFS is a registered trademark of Global Finishing Solutions USA, Wagner is a registered trademark of Wagner Systems, Inc., Gema is a registered trademark of ITW Gema, Deimco is a registered trademark of Deimco Finishing Equipment, Torit is a registered trademark of Donaldson Co., Inc., Nordson is a registered trademark of Nordson Corporation.



866-ASK-EPSI (866-275-3774)  
866-FAX-EPSI (866-329-3774)

110

Order online at  
[www.epsi.com](http://www.epsi.com)

**YOU ASK IT.  
WE MASK IT.®**



NORDSON® PART NUMBER	EPSI PART NUMBER	DESCRIPTION
101412	FILC10001100QX	12.75"x26.0" Open(Tr-Bolt Cap)/Closed, QX Media
147161	FILC10001100QX	12.75"x26.0" Open(Tr-Bolt Cap)/Closed, QX Media
146167	FILC10001100QX	12.75"x26.0" Open(Tr-Bolt Cap)/Closed, QX Media
146417	FILC10003961SB	12.859"x26.0" Open(Tri-Bolt Cap)/Closed, SB Media
147160	FILC10001101QX	12.75"x26.0" Open/Closed w/Bolt Hole, QX Media
101411	FILC10001101QX	12.75"x26.0" Open/Closed w/Bolt Hole, QX Media
147162	FILC10001102QX	12.75"x26.0" Open/Open, QX Media
147163	FILC10001103QX	12.75"x26.0" Open/Closed, QX Media
101413	FILC10001102QX	12.75"x26.0" Open/Open, QX Media
147162	FILC10001102QX	12.75"x26.0" Open/Open, QX Media
151085	FILC10001536SB	12.75"x36.0" Open/Open, 2 Bands, SB Media
158660	FILC10004219QX	12.75"x26.0" Open/Closed w / Inner Nut, QX Media
180775	FILC10004166SB	12.75"x32.0" Open/Closed w / Inner Nut, 2 Bands, SB Media
156996	FILC10005455SB	12.75"x36.0" Open/Closed w/Bolt Hole, 2 Bands, SB Media
101431	FILC10003830MF	24"x20"x2.25" Final Filter, Metal Frame
101432	FILC10003772MF	24"x18"x2.25" Final Filter, Metal Frame
156995	FILC30000533SH	24x20x12 Ashrae Final Filter, No Gasket, Singlr Header
156995	FILC30000690DH	24x20x12 Ashrae Final Filter, No Gasket, Double Header

GFS® PART NUMBER	EPSI PART NUMBER	DESCRIPTION
216-202	FILC10005446FR	12.75"x26.0" Open/Closed w/Bolt Hole, FR Media
216-203	FILC10005559QX	12.75"0x26.0" Open/Open, QX Media
216-204	FILC10005313QX	12.75"0x26.0" Open/Closed w/Bolt Hole, 2 Bands, QX Media

WAGNER® PART NUMBER	EPSI PART NUMBER	DESCRIPTION
FIL-1060	FILC10001407QX	12.75"x26.0" Open/Open, QX Media
FIL-1080	FILC10001694SB	12.75"x26.0" Open/Open, SB Media

GEMA® PART NUMBER	EPSI PART NUMBER	DESCRIPTION
105164	FILC10000016QX	12.75"x26.0" Open/Open, QX Media
109428	FILC10000155QX	12.75"x26.0" Open/Closed w/ Farr Style Flange, QX Media
116870	FILC10001901QX	13.865"x23.0" Open/Open, QX Media
115562	FILC10000667QX	13.865"x26.0" Open/Open, QX Media

DEIMCO® PART NUMBER	EPSI PART NUMBER	DESCRIPTION
V05400	FILC10005497QX	13.865"x26.0" Open/Closed, QX Media
VO6240	FILC10003201QX	13.865"x26.0" Open/Open, QX Media
VO6250	FILC10003200QX	13.865"x26.0" Open/Closed w/Bolt Hole, QX Media

TORIT® PART NUMBER	EPSI PART NUMBER	DESCRIPTION
P526592-016-340	FILC10001100QX	12.75"x26.0" Open(Tr-Bolt Cap)/Closed, QX Media
P526591-016-340	FILC10001101QX	12.75"x26.0" Open/Closed w/Bolt Hole, QX Media
P19-0817-461-436	FILC10003201QX	13.865"x26.0" Open/Open, QX Media

<b>CX MEDIA</b>	<b>Cellulose</b>
<b>QX MEDIA</b>	<b>80/20 Blend of Cellulose and Polyester Media</b>
<b>SB MEDIA</b>	<b>Spun Bond Polyester Media</b>
<b>QX-FR</b>	<b>QX Media w/Flame Retardant Treatment</b>



866-ASK-EPSI (866-275-3774)  
866-FAX-EPSI (866-329-3774)

111

Order online at  
[www.epsi.com](http://www.epsi.com)

**YOU ASK IT.  
WE MASK IT.®**

# PG Green Paint Pockets™

## Liquid Filters

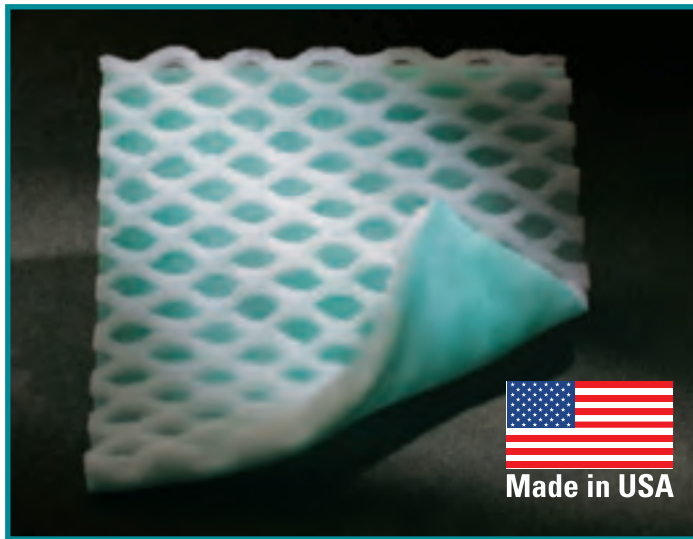

■ 99.43% Efficient

■ Holds 5x More Paint than the Leading Arrestor

■ Cuts Changing Filters by 80%

■ Most Economical Paint Pocket

### TYPICAL INDUSTRY USES

Liquid Spray Coating including medium and high solid paints, water reduced paints, plural component coating, stains and adhesives.

### TYPICAL APPLICATIONS

The Paint Pockets Green overspray arrestors is the best value for production spray booths. Specifically priced to replace expanded paper, fiberglass and other lower efficiency, lower value filters. The intricate fiber structure and three dimensional design holds up to five times more overspray without losing efficiency. Three filters can hold up to 6 pounds per square foot and yet due to their

special construction they won't tear or sag. The PPG product line saves you money by having to use fewer filters, taking less time for change-over and lower disposal costs of used filters.

### SPECIFICATIONS

Overall Arrestance Efficiency	99.43%
Holding Capacity	Up to 6 lbs/sq ft
Tested Air Velocity	150 FPM
Initial Pressure Drop	0.04 in W.C.
Maximum Pressure Drop	1.00 in W.C.
Flammability Rating	UL Class II
Filter Construction	High Loft, Multi Ply Non-woven Polyester

## PG SERIES

PART NUMBER	DESCRIPTION	CASE QTY	UNIT SHIPPING WEIGHT
PGP-0020-0020	20" x 20" Pads	40/Case	13.5 lbs.
PGP-0020-0025	20" x 25" Pads	40/Case	15.8 lbs.
PGB-0030-0720	30" x 60' Blanket	1/Pkg.	13.2 lbs.
PGB-0036-0720	36" x 60' Blanket	1/Pkg.	15.4 lbs.
PGB-0048-0720	48" x 60' Blanket	1/Pkg.	20.5 lbs.
PGB-0060-0720	60" x 60' Blanket	1/Pkg.	25.4 lbs.



866-ASK-EPSI (866-275-3774)  
866-FAX-EPSI (866-329-3774)

112

Order online at  
[www.epsi.com](http://www.epsi.com)

**YOU ASK IT.  
WE MASK IT.®**

# PW White Paint Pockets™

## Liquid Filters



- 99.43% Efficient But Lasts 3x Longer
- Holds 5x More Paint than the Leading Arrestor
- Cuts Changing Filters by 80%
- Excellent at Capturing 2.5 to 10 Micron Particles

### TYPICAL INDUSTRY USES

Liquid Spray Coating including medium and high solid paints, water reduced paints, plural component coating, stains and adhesives.

### TYPICAL APPLICATIONS

Premium single stage overspray arrestor; knocks down and retains overspray keeping overspray out of your exhaust stacks and off booth floors. Unique design holds 5x more overspray than other filters by utilizing the patented three dimensional pocket that more than doubles its surface area.

### SPECIFICATIONS

Overall Arrestance Efficiency	99.84%
Fractional Arrestance Efficiency:	
20 microns	100.0%
10 microns	99.8%
5 microns	84.5%
2.5 microns	4.2%
Holding Capacity	Up to 6 lbs/sq ft
Tested Air Velocity	700 FPM
Initial Pressure Drop	0.06 in W.C.
Maximum Pressure Drop	1.00 in W.C.
Flammability Rating	UL Class II
Filter Construction	High Loft, Multi Ply Non-woven Polyester

## PW SERIES

PART NUMBER	DESCRIPTION	CASE QTY	UNIT SHIPPING WEIGHT
PWP-0020-0020	20" x 20" Pads	30/Case	13.5 lbs.
PWP-0020-0025	20" x 25" Pads	30/Case	15.2 lbs.
PWB-0024-0600	24" x 50' Blanket	1/Pkg.	10.6 lbs.
PWB-0030-0600	30" x 50' Blanket	1/Pkg.	13.2 lbs.
PWB-0036-0600	36" x 50' Blanket	1/Pkg.	15.7 lbs.
PWB-0040-0600	40" x 50' Blanket	1/Pkg.	17.3 lbs.
PWB-0045-0600	45" x 50' Blanket	1/Pkg.	19.4 lbs.
PWB-0048-0600	48" x 50' Blanket	1/Pkg.	20.6 lbs.
PWB-0060-0600	60" x 50' Blanket	1/Pkg.	25.7 lbs.



866-ASK-EPSI (866-275-3774)  
866-FAX-EPSI (866-329-3774)

113

Order online at  
[www.epsi.com](http://www.epsi.com)



# CRSP Cork Spacer Pads



- Protect Finished Products During Shipping and Storage
- Spacer Pads Stick without Adhesive
- Fast, Easy Placement and Removal
- Inexpensive Cork Material; Reusable
- Parts Can be Stacked Shortly After Curing

## TYPICAL INDUSTRY USES

Powder Coating, E-Coating, Plating, Anodizing and Wet Spray

## TYPICAL APPLICATIONS

Used as a protective spacer between layers of freshly coated material to prevent damage and wear to surfaces.



## HELPFUL HINTS

A simple system for avoiding paint damage during storage and transportation. The spacer pads are 18 X 18mm or 20 X 20mm in varying thickness, and made of natural cork with a 2 mm thick soft polyethylene layer on one side. The pad fastens with a suction effect when lightly pressed against the painted surface. The pads do not leave any trace after removal, and can be reused. We do, however, recommend that this product be tested first to determine the suitability for its intended paint application.

## CRSP SERIES

PART NUMBER	STANDARD		METRIC		BOX QTY
	BASE (IN)	THICKNESS (IN)	BASE (MM)	THICKNESS (MM)	
CRSP 181804	0.709X0.709	0.157	18.0X18.0	4.0	6000
CRSP 202010	0.787X0.787	0.394	20.0X20.0	10.0	4500



866-ASK-EPSI (866-275-3774)  
866-FAX-EPSI (866-329-3774)

114

Order online at  
[www.epsi.com](http://www.epsi.com)

**YOU ASK IT.  
WE MASK IT.®**





# Conversion Table

FRACTION	DECIMALS	MILLIMETERS	FRACTION	DECIMALS	MILLIMETERS		
	1/64	0.0156	0.40		33/64	0.5156	13.10
	1/32	0.0313	0.80		17/32	0.5313	13.50
	3/64	0.0469	1.20		35/64	0.5469	13.90
<b>1/16</b>	<b>0.0625</b>	<b>1.59</b>		<b>9/16</b>	<b>0.5625</b>	<b>14.29</b>	
	5/64	0.0781	1.99		37/64	0.5781	14.69
	3/32	0.0938	2.39		19/32	0.5938	15.09
	7/64	0.1094	2.78		39/64	0.6094	15.48
<b>1/8</b>	<b>0.1250</b>	<b>3.18</b>		<b>5/8</b>	<b>0.6250</b>	<b>15.88</b>	
	9/64	0.1406	3.58		41/64	0.6406	16.28
	5/32	0.1563	3.97		21/32	0.6563	16.67
	11/64	0.1719	4.37		43/64	0.6719	17.07
<b>3/16</b>	<b>0.1875</b>	<b>4.77</b>		<b>11/16</b>	<b>0.6875</b>	<b>17.47</b>	
	13/64	0.2031	5.16		45/64	0.7031	17.86
	7/32	0.2188	5.56		23/32	0.7188	18.26
	15/64	0.2344	5.96		47/64	0.7344	18.66
<b>1/4</b>	<b>0.2500</b>	<b>6.35</b>		<b>3/4</b>	<b>0.7500</b>	<b>19.05</b>	
	17/64	0.2656	6.75		49/64	0.7656	19.45
	9/32	0.2813	7.15		25/32	0.7813	19.85
	19/64	0.2969	7.55		51/64	0.7969	20.25
<b>5/16</b>	<b>0.3125</b>	<b>7.94</b>		<b>13/16</b>	<b>0.8125</b>	<b>20.64</b>	
	21/64	0.3281	8.34		53/64	0.8281	21.04
	11/32	0.3438	8.74		27/32	0.8438	21.44
	23/64	0.3594	9.13		55/64	0.8594	21.83
<b>3/8</b>	<b>0.3750</b>	<b>9.53</b>		<b>7/8</b>	<b>0.8750</b>	<b>22.23</b>	
	25/64	0.3906	9.93		57/64	0.8906	22.63
	13/32	0.4063	10.32		29/32	0.9063	23.02
	27/64	0.4219	10.72		59/64	0.9219	23.42
<b>7/16</b>	<b>0.4375</b>	<b>11.12</b>		<b>15/16</b>	<b>0.9375</b>	<b>23.82</b>	
	29/64	0.4531	11.51		61/64	0.9531	24.21
	15/32	0.4688	11.91		31/32	0.9688	24.61
	31/64	0.4844	12.31		63/64	0.9844	25.01
<b>1/2</b>	<b>0.5000</b>	<b>12.70</b>		<b>1</b>	<b>1.0000</b>	<b>25.40</b>	



866-ASK-EPSI (866-275-3774)  
866-FAX-EPSI (866-329-3774)

Order online at  
[www.epsi.com](http://www.epsi.com)



# Terms & Conditions

## Payment:

- Minimum order is \$75.00 U.S. Dollars.
- Payment can be made using Visa/Master Card/American Express/Discover Card.
- 10 Net 30 Days on Approved Credit.
- Delivery Terms, FOB regional facility.
- Late payments are subject to a finance charge of 1.5% (18% APR) on unpaid balances until paid, and any collection costs including actual attorney fees.

## Returns:

- All claims and returns must be made within 15 days from the invoice date.
- All returns must have an RMA (Return Material Authorization) number. No returns will be accepted without an RMA number. Please contact our customer service desk at 1-866-275-3774 or your Sales Representative to request a RMA number. Orders must be returned with the RMA number on the outside of the shipping box. RMAs expire 15 days after date of issuance.
- A 15% restocking fee will apply for items returned that are not defective. All items must be in original packaging and show no signs of use.
- Custom and special ordered products cannot be returned unless defective.

## Limitations of Damages:

In no event shall EPSI be liable, in contract, tort, strict liability, or under any other legal theory, for indirect, incidental, consequential, special, or punitive damages, or for loss of profit, revenue or data, regardless of whether EPSI was informed about the possibility of such damage, and in no event shall EPSI's total liability exceed an amount equal to the sale price actually paid by buyer.

## Disclaimer:

Many factors can affect the use and performance of a product in a particular application. All products in this catalog should be tested to determine their suitability for their intended use.

Temperatures listed for all products in this catalog are the highest intermittent temperature this product should be exposed to (unless otherwise specified), and is given as a general guideline. These temperatures are higher than the continuous operating temperature for a given material.

When choosing a material for an application where hardness, chemical resistance, weatherability, tear resistance or other such properties are important, EPSI will gladly send samples of our stock materials for your evaluation. For additional material properties, or help in selecting the right material for your job, see "Elastomer Selection Guide" at the end of the catalog on page 115 or contact an EPSI Representative at 1.866.275.3774.



- ▷ The highest quality products at competitive prices.
- ▷ Is a proven designer of custom applications.
- ▷ Has the most patented products on the market.
- ▷ Is a leading manufacturer of masking and custom molded components.

**WE TAKE CHALLENGES  
AND TURN THEM INTO GREAT PRODUCTS!**

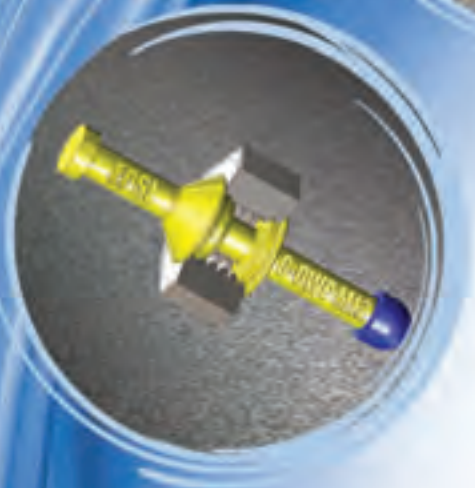

**YOU ASK IT.  
WE MASK IT.®**



[www.epsi.com](http://www.epsi.com) [sales@epsi.com](mailto:sales@epsi.com)

866-ASK-EPSI (866-275-3774)  
866-FAX-EPSI (866-329-3774)